

The Harmonic Series for Every Occasion

Steven J. Kifowit

Prairie State College

November 12, 2017

Abstract

Harmonic series proofs and applications can entertain, inform, and excite. The presenter was once challenged by some motivated students to use the harmonic series in an example of each topic covered in class. In this presentation, you will see some of those efforts toward a harmonic series for every occasion.

Goals

- 1 Use the harmonic series as a recurring theme in examples and applications that pique student interest.
- 2 Discuss several new proofs of harmonic divergence.
- 3 Use the harmonic series in unusual ways in examples for calculus topics where the harmonic series is not typically used.
- 4 Discuss ideas for motivating student learning of infinite series and overcoming common cognitive obstacles associated with sequences and series.

The harmonic series—Some background info

- The harmonic series diverges.

$$\sum_{n=1}^{\infty} \frac{1}{n} = 1 + \frac{1}{2} + \frac{1}{3} + \frac{1}{4} + \cdots = \infty$$

- First known divergence proof is due to Oresme, circa 1350.
- The Larson calculus text incorrectly attributes the proof to James (Jacob) Bernoulli.
- $H_n = 1 + \frac{1}{2} + \frac{1}{3} + \cdots + \frac{1}{n}$ is called the n th *harmonic number*.

Harmonic divergence via geometric series

Choose a positive integer k .

$$\begin{aligned} \sum_{n=1}^{\infty} \frac{1}{n} &= 1 + \overbrace{\left(\frac{1}{2} + \cdots + \frac{1}{k+1} \right)}^{k \text{ terms}} + \overbrace{\left(\frac{1}{k+2} + \cdots + \frac{1}{k^2+k+1} \right)}^{k^2 \text{ terms}} \\ &\quad + \overbrace{\left(\frac{1}{k^2+k+2} + \cdots + \frac{1}{k^3+k^2+k+1} \right)}^{k^3 \text{ terms}} + \cdots \end{aligned}$$

Harmonic divergence via geometric series (cont.)

$$\begin{aligned}\sum_{n=1}^{\infty} \frac{1}{n} &= \dots \\ &> 1 + \frac{k}{k+1} + \frac{k^2}{k^2+k+1} + \frac{k^3}{k^3+k^2+k+1} + \dots \\ &> 1 + \left(\frac{k}{k+1}\right) + \left(\frac{k}{k+1}\right)^2 + \left(\frac{k}{k+1}\right)^3 + \dots \\ &= \frac{1}{1 - \frac{k}{k+1}} = k + 1\end{aligned}$$

Harmonic divergence via geometric series (cont.)

Students may find this proof difficult.

- There is some algebra to check.
- How exactly does it establish divergence?
- Which tests are being used?
- Isn't a divergent series being compared to a convergent series?

Harmonic divergence via telescoping series

This next divergence proof has appeared several times in the literature [1, 2].

We start by recognizing that

$$x \geq \ln(1 + x)$$

so that

$$\frac{1}{k} \geq \ln\left(1 + \frac{1}{k}\right) = \ln(k + 1) - \ln(k)$$

for any positive integer k .

Harmonic divergence via telescoping series (cont.)

$$\begin{aligned}H_n &= \sum_{k=1}^n \frac{1}{k} \\&\geq \sum_{k=1}^n \ln\left(1 + \frac{1}{k}\right) = \sum_{k=1}^n [\ln(k+1) - \ln(k)] \\&= [\ln(n+1) - \ln(n)] + [\ln(n) - \ln(n-1)] + \cdots + [(\ln(2) - \ln(1))] \\&= \ln(n+1).\end{aligned}$$

Harmonic divergence via telescoping series (cont.)

- How is divergence established?
- How does the proof differ from the last proof?

Harmonic divergence via limit comparison

In the last proof, the harmonic series was directly compared to the divergent telescoping series $\sum_{k=1}^{\infty} \ln\left(1 + \frac{1}{k}\right)$. Limit comparison is simpler.

$$\lim_{x \rightarrow \infty} \frac{\ln\left(1 + \frac{1}{x}\right)}{\frac{1}{x}} = \lim_{x \rightarrow \infty} \frac{-\frac{1}{x^2}}{\left(1 + \frac{1}{x}\right)\left(-\frac{1}{x^2}\right)} = 1$$

Harmonic divergence—A proof without words

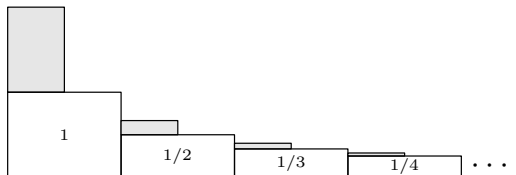
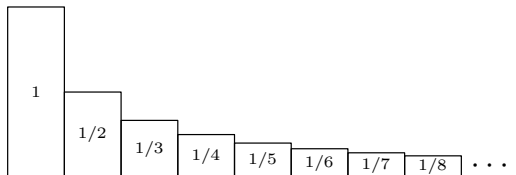

Harmonic divergence—A proof without words (cont.)

The preceding proof is a visual rendition of this proof,

$$\begin{aligned} \left(1 + \frac{1}{2}\right) + \left(\frac{1}{3} + \frac{1}{4}\right) + \left(\frac{1}{5} + \frac{1}{6}\right) + \left(\frac{1}{7} + \frac{1}{8}\right) + \cdots \\ > \frac{2}{2} + \frac{2}{4} + \frac{2}{6} + \frac{2}{8} + \cdots, \end{aligned}$$

which has appeared in a number of places [3, 6, 7].

The idea that something is “bigger than itself” may be new to students.

The harmonic series and the Riemann hypothesis

Lagarias [8] discovered an occasion to use the harmonic series that stunningly connects the Riemann hypothesis to an elementary problem.

Let $\sigma(n)$ be the sum of all positive divisors of the natural number n . Lagarias showed that the Riemann hypothesis is equivalent to the assertion that

$$\sigma(n) \leq H_n + e^{H_n} \ln(H_n)$$

for every natural number n .

The harmonic series and the Riemann hypothesis (cont.)

In the interest of using deep and profound results for rather trivial things, here is a new argument for harmonic divergence:

- 1 Assume the Riemann hypothesis (which is reasonable).
- 2 $\sigma(n)$ obviously approaches ∞ as $n \rightarrow \infty$.
- 3 By Lagarias's result, H_n must be unbounded. ■

An algebra problem

A group of people have a big job to do. Person 1 can do the job by herself in 1 hr, person 2 can do the job in 2 hr, and in general, person n requires n hr. How long does it take them to do the job if they all work together?

Well, the k th person does one- k th of the job per hour. So working all together, they do

$$H_n = 1 + \frac{1}{2} + \frac{1}{3} + \cdots + \frac{1}{n}$$

jobs per hour, or $1/H_n$ hours per job.

An algebra problem (cont.)

In this context, what is the best way to measure the “average” number of hours per job?

Arithmetic mean: $\frac{1 + 2 + \cdots + n}{n}$ or Harmonic mean: $\frac{n}{H_n}$

The arithmetic mean captures the “average” if each person does the same number of jobs, while the harmonic mean captures the “average” if each person works the same number of hours.

In the U.S., corporate average fuel economy standards have used the harmonic mean since the Arab Oil Embargo.

Harmonic divergence via arc length

In polar coordinates, consider the hyperbolic spiral defined on $[\pi, \infty)$ by $r(\theta) = \pi/\theta$ and the *harmonic spiral* defined by

$$\rho(\theta) = \begin{cases} 1, & \pi \leq \theta < 2\pi \\ 1/2, & 2\pi \leq \theta < 3\pi \\ \vdots & \vdots \\ 1/n, & n\pi \leq \theta < (n+1)\pi \\ \vdots & \vdots \end{cases}$$

Harmonic divergence via arc length (cont.)

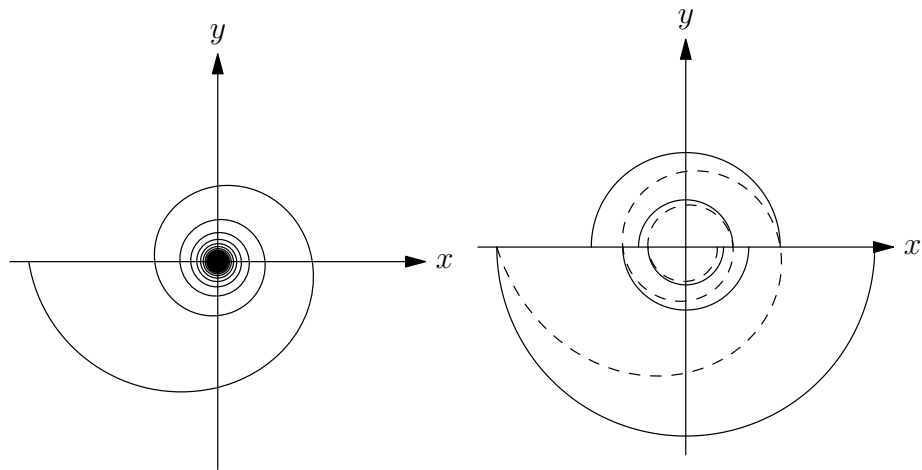

Figure: Hyperbolic spiral.

Figure: Hyperbolic (dashed) and harmonic (solid) spirals.

Harmonic divergence via arc length (cont.)

The hyperbolic spiral is infinitely long:

$$\int_{\pi}^{\infty} \sqrt{r^2 + \left(\frac{dr}{d\theta}\right)^2} d\theta \geq \int_{\pi}^{\infty} \sqrt{r^2} d\theta = \int_{\pi}^{\infty} r d\theta =$$
$$\int_{\pi}^{\infty} \frac{\pi}{\theta} d\theta = \pi \ln \theta \Big|_{\pi}^{\infty} = \infty.$$

The harmonic spiral is at least as long, and its length is given by

$$\pi + \frac{\pi}{2} + \frac{\pi}{3} + \frac{\pi}{4} + \cdots = \pi \sum_{n=1}^{\infty} \frac{1}{n}.$$

Harmonic divergence via arc length (cont.)

- This is essentially the integral test approach to proving divergence.
- But the arc length approach puts the harmonic series into a context.

Harmonic series in indeterminate forms

Beginning students often question what makes an indeterminate form indeterminate.

In the case of $\infty - \infty$, simple examples such as

$$\lim_{x \rightarrow \infty} (x - x) = 0, \quad \lim_{x \rightarrow \infty} (2x - x) = \infty, \quad \text{and} \quad \lim_{x \rightarrow \infty} ((x + 1) - x) = 1$$

sometimes make an impression, and they help to indicate that rearrangement can be crucial.

Harmonic series in indeterminate forms (cont.)

The $\infty - \infty$ form obtained from

$$\sum_{n=1}^{\infty} \frac{1}{2n-1} - \sum_{n=1}^{\infty} \frac{1}{2n}$$

is a nice example to show just how indeterminate an indeterminate form can be.

Based on Riemann's rearrangement theorem, which Dunham [4, p. 114] whimsically calls "Riemann's remarkable rearrangement result", the terms of the series can be rearranged to give **any** prescribed value.

Harmonic series in indeterminate forms (cont.)

Another nice example of an $\infty - \infty$ form involving the harmonic series comes from the definition of Euler's constant

$$\gamma = \lim_{n \rightarrow \infty} \left(\sum_{k=1}^n \frac{1}{k} - \ln n \right).$$

Harmonic series in solids of revolution

Gabriel's horn is obtained by rotating the graph of $y = 1/x$, $1 \leq x < \infty$, about the x -axis.

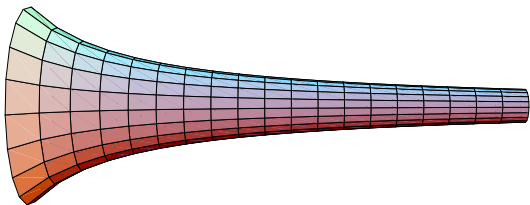

- Gabriel's horn has finite volume but infinite surface area.
- It is often said that the horn can be filled with paint, but cannot be painted.

Harmonic series in solids of revolution (cont.)

Gabriel's wedding cake [5] is a discrete analogue of Gabriel's horn.

Rotate the graph of $y = f(x)$, $1 \leq x < \infty$, about the x -axis.

$$f(x) = \begin{cases} 1, & 1 \leq x < 2 \\ 1/2, & 2 \leq x < 3 \\ \dots & \dots \\ 1/n, & n \leq x < n+1 \\ \dots & \dots \end{cases}$$

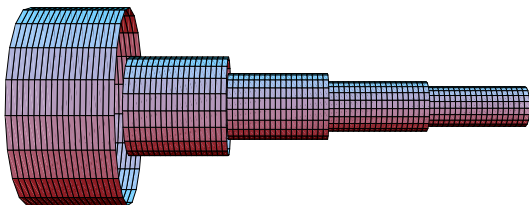

Harmonic series in solids of revolution (cont.)

- The cake has volume

$$V = \sum_{n=1}^{\infty} \pi \left(\frac{1}{n}\right)^2 (1) = \pi \sum_{n=1}^{\infty} \frac{1}{n^2} = \frac{\pi^3}{6}.$$

- The cake has lateral surface area

$$A = \sum_{n=1}^{\infty} 2\pi \left(\frac{1}{n}\right) (1) = 2\pi \sum_{n=1}^{\infty} \frac{1}{n}.$$

- Since the harmonic series diverges, Gabriel's wedding cake is a cake you can eat, but cannot frost.

Harmonic series in solids of revolution (cont.)

The paradoxical paint pail described by Lynch [9]...

Define f on $[0, 1]$ as follows: $f(x) = 1$ if $x = 0$ or if $x = 1/n$ for n a positive integer, and on the interval $(\frac{1}{n+1}, \frac{1}{n})$, the graph of f is a symmetric spike of arc length $1/n$.

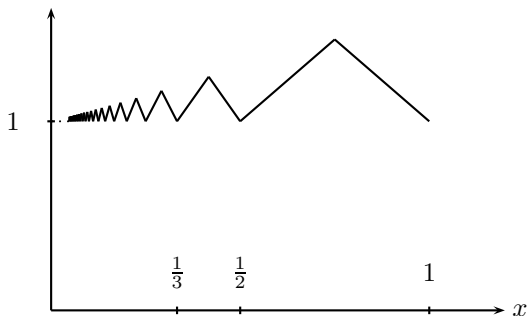

Harmonic series in solids of revolution (cont.)

Since the harmonic series diverges, the arc length is infinite.

Rotate the graph about the x -axis to generate a solid that

- is bounded,
- has infinite surface area, and
- has finite volume.

Notice that the derivative of the paint-pail function has infinitely many discontinuities.

Harmonic series in solids of revolution (cont.)

Gabriel's beer glass...

For $0 \leq x \leq 2$, define the function f as follows:

$$f(x) = \begin{cases} 2 + x \cos(\pi/x), & 0 < x \leq 2 \\ 2, & x = 0 \end{cases}$$

- f is continuous on $[0, 2]$ and f' is continuous on $(0, 2]$.
- For any natural number n , the vertical distance from the point $(1/n, 2)$ to the graph of f is $1/n$ units. Therefore the graph is at least as long as $\sum \frac{1}{n} = \infty$.

Harmonic series in solids of revolution (cont.)

Rotate the graph of f about the x -axis.

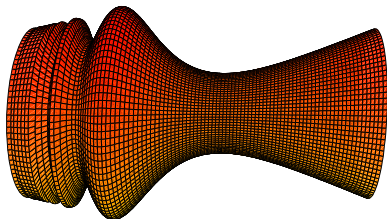

- The solid is bounded.
- Its surface area is infinite.
- Its volume is finite.
- Its defining function has a continuous derivative everywhere except at $x = 0$.

Harmonic series in solids of revolution (cont.)

A nice survey of these types of solids is given by Royer [11].

Harmonic series in expected value

This occasion to use the harmonic series begins with another series that is well known to calculus students:

$$\sum_{n=1}^{\infty} \frac{1}{n(n+1)} = \frac{1}{2} + \frac{1}{6} + \frac{1}{12} + \frac{1}{20} + \cdots$$

After rewriting the terms via partial fractions, this is the quintessential telescoping series.

Harmonic series in expected value (cont.)

Pfaff and Tran [10] took a different approach.

A red marble and a blue marble are placed into an jar. A marble is drawn at random. If the marble is blue, you win. Otherwise, replace the red marble, add another red marble, and repeat the process until you win.

Here is the probability tree diagram for a few stages of the game.

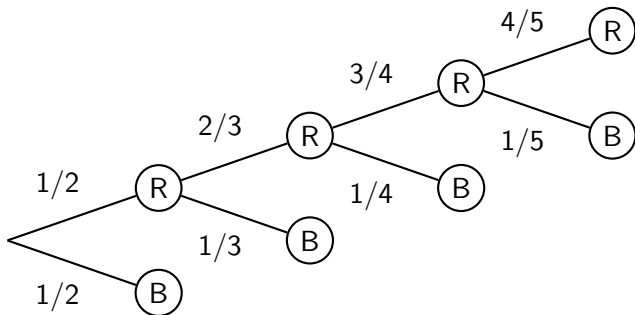

Harmonic series in expected value (cont.)

For each positive integer n , let B_n be the event of winning (i.e., selecting blue) on the n th draw.

- The events are exclusive.
- $P(B_n) = 1/[n(n+1)]$.
- The probability of winning (eventually) is given by

$$P(B_1) + P(B_2) + P(B_3) + P(B_4) + \cdots = \frac{1}{2} + \frac{1}{6} + \frac{1}{12} + \frac{1}{20} + \cdots .$$

Now let R_n be the event of drawing n consecutive red marbles.

- $P(R_n) = 1/(n+1)$.
- Since $P(R_n) \rightarrow 0$, the events B_n exhaust the sample space.
- So you must eventually draw a blue marble, and the series above must converge to 1.

Harmonic series in expected value (cont.)

The expected number of draws required to win is given by

$$1 P(B_1) + 2 P(B_2) + 3 P(B_3) + \cdots = \sum_{n=1}^{\infty} \frac{n}{n(n+1)} = \sum_{n=1}^{\infty} \frac{1}{n+1}.$$







Since the harmonic series diverges, *this is a game you will win, but it should take forever.*

Thanks for coming!





I have lots more occasions to use the harmonic series.
Please feel free to contact me.

Steve Kifowit
Prairie State College
skifowit@prairiestate.edu
stevekifowit.com

References I

-  [1] R. L. Baker, An exceedingly short proof that the harmonic series diverges, *Missouri J. Math. Sci.* **27** (2015) 95-96.
-  [2] D. M. Bradley, A note on the divergence of the harmonic series, *Amer. Math. Monthly* **107** (2000) 651.
-  [3] M. R. Chowdhury, The harmonic series again, *Math. Gazette* **59** (1975) 186.
-  [4] W. Dunham, *The Calculus Gallery: Masterpieces from Newton to Lebesgue*, Princeton University Press, 2005.
-  [5] J. F. Fleron, Gabriel's wedding cake, *College Math. J.* **30** (1999) 35–38.
-  [6] L. Goldmakher, A short(er) proof of the divergence of the harmonic series (2016),
<https://web.williams.edu/Mathematics/lg5/harmonic.pdf>.

References II

-  [7] R. Honsberger, *Mathematical Gems II*, MAA Press, Washington, DC, 1976.
-  [8] J. C. Lagarias, An elementary problem equivalent to the Riemann hypothesis, *Amer. Math. Monthly* **109** (2002) 534–543.
-  [9] M. Lynch, A Paradoxical Paint Pail, *College Math. J.* **36** (2005) 402–404.
-  [10] T. J. Pfaff and M. N. Tran, Series that probably converge to one, *Math. Mag.* **82** (2009) 42–49.
-  [11] M. Royer, Gabriel's other possessions, *PRIMUS* **22** (2012) 338–351.

Oresme's Proof

$$\begin{aligned} 1 + \frac{1}{2} + \left(\frac{1}{3} + \frac{1}{4}\right) + \left(\frac{1}{5} + \cdots + \frac{1}{8}\right) + \left(\frac{1}{9} + \cdots + \frac{1}{16}\right) + \cdots \\ > 1 + \frac{1}{2} + \frac{2}{4} + \frac{4}{8} + \frac{8}{16} + \cdots \end{aligned}$$

