



TOCICO 2013 Conference

Basics Workshop: Project and Multi-Project Management (English)

**Presented By: James R. Holt, Ph.D., PE
FE, BSCI, PMCI, SCLCI, TPCI**

Date: June 2013

If you have already implemented Critical Chain Project Management, please attend the Advanced Project Management Workshop.

Agenda

TOCICO 2013 Conference

- **Examine:**
 - **The Nature of Projects.**
 - **The Nature of Tasks.**
 - **The Behavior of People.**
 - **The Problems with Traditional Project Scheduling.**
 - **Critical Chain Project Management Scheduling.**
 - **Managing Project Execution.**
 - **Dealing with Multi-Projects.**
 - **A Quiz.**

**And, we will play
a few games
along the way.**



The Nature of Projects

Intro to Critical Chain Project Management

TOCICO 2013 Conference

- **Projects Are:**
 - **Unique.**
 - **Dependent on Precedence.**
 - **Activities Not Well Known.**
 - **Highly Variable.**
 - **Share Resources.**
 - **Concurrent with Other Projects.**
 - **Valued by Scope, Schedule and Cost.**

Projects are Balancing Acts

TOCICO 2013 Conference

**Quality and
Scope**

**Timing and
Schedule**

**Budgeted
Costs**

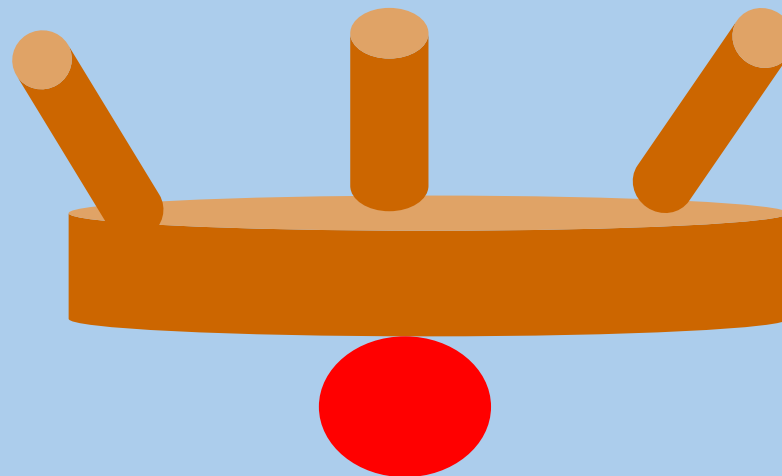

Then Things Combine

TOCICO 2013 Conference

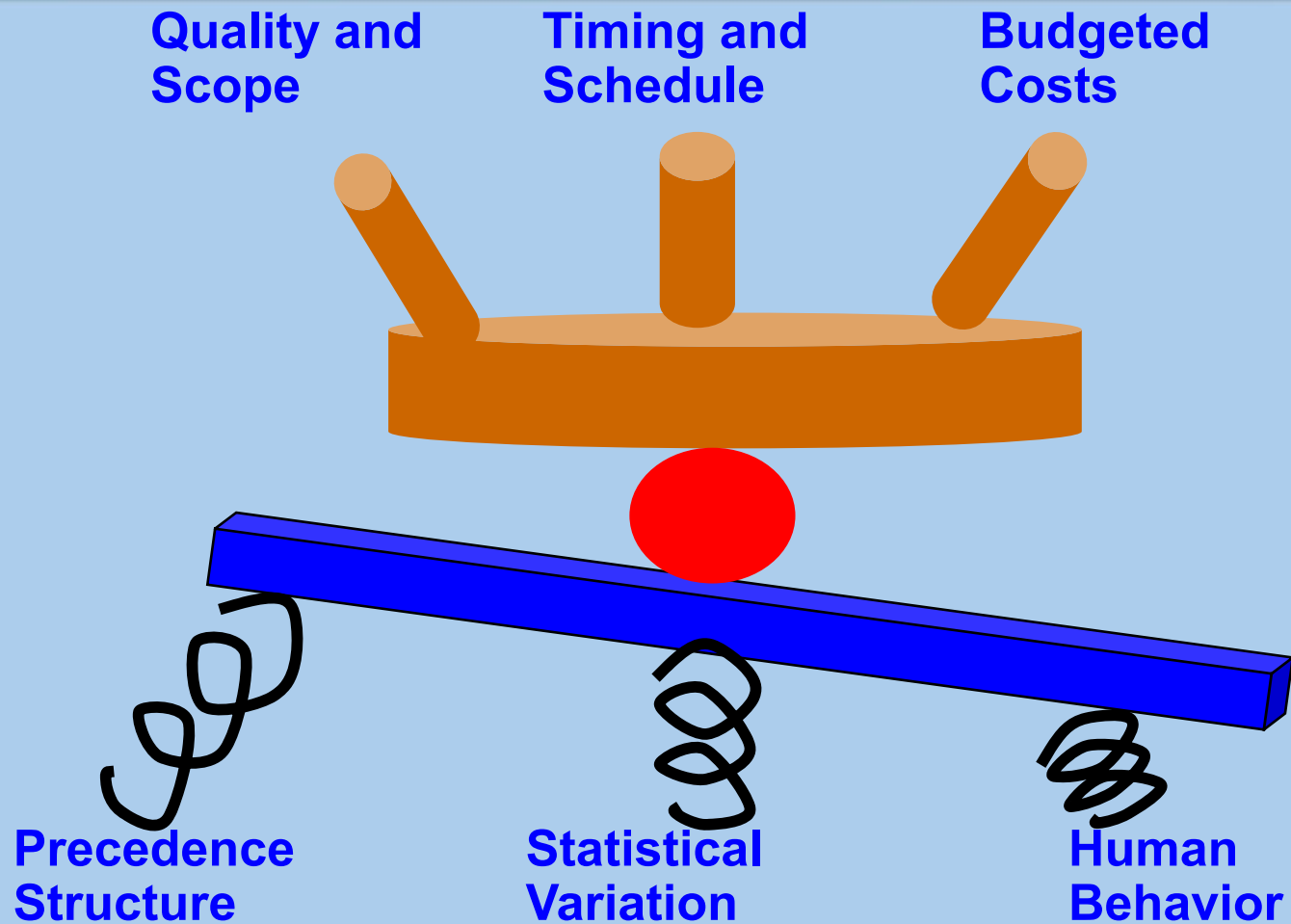

And Reality Sets In

TOCICO 2013 Conference

Quality and
Scope

Timing and
Schedule

Budgeted
Costs

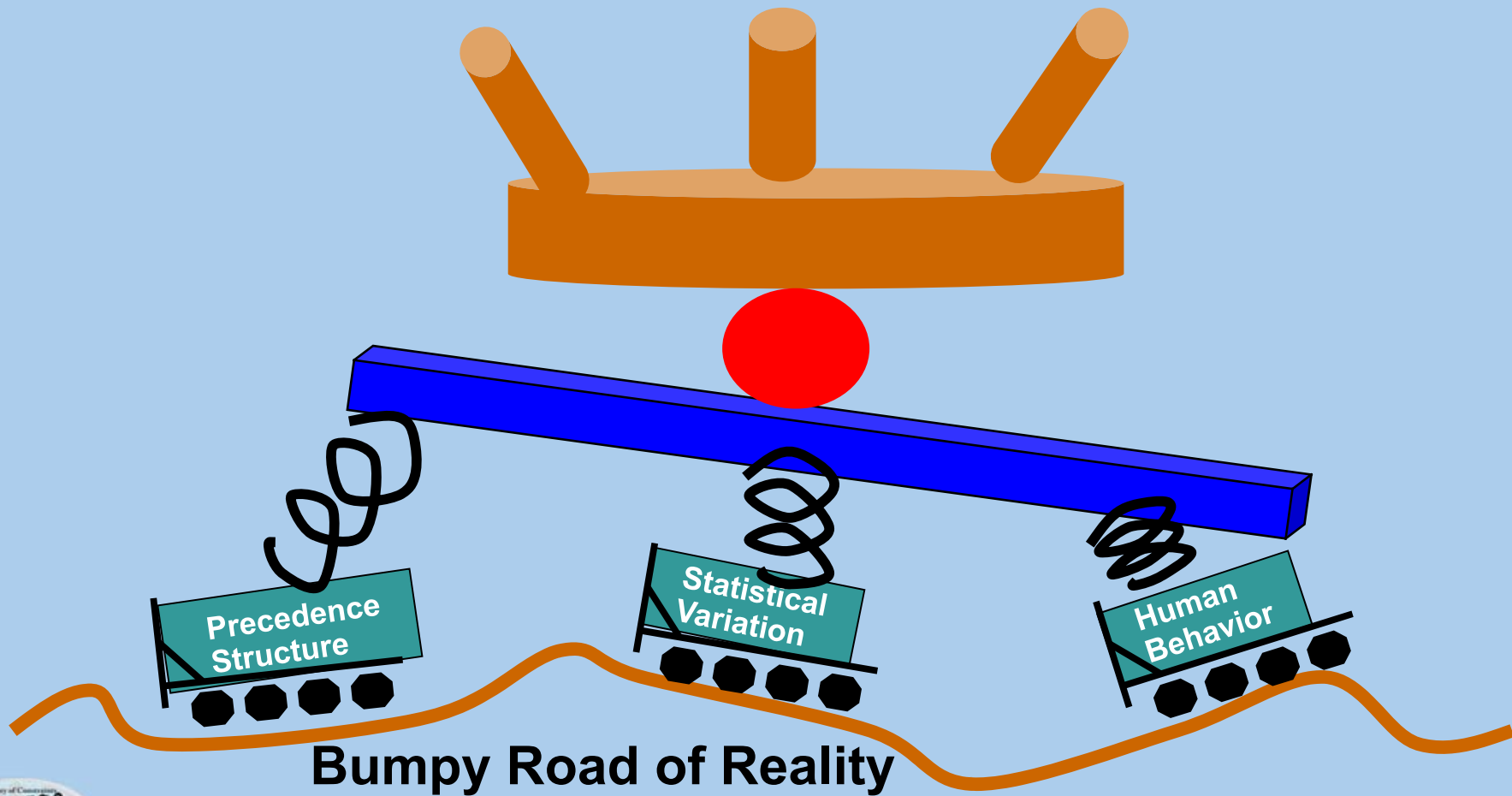

Bumpy Road of Reality

The Core Problem (Constraint)

TOCICO 2013 Conference

High variability in the project leads to some misestimates in schedule, cost and content.

Interconnected commitments tie our hands. What are we to do?



Undesirable Effects of Projects

TOCICO 2013 Conference

- **Projects Are:**
 - **Usually Late (jeopardized schedule).**
 - **Have Too Many Changes (changed scope).**
 - **Often Over Budget (jeopardized cost).**
 - **Lots of Rework (added to cost, schedule).**
 - **Many Priority Battles.**
 - **Resources Not Available When Needed.**
 - **Project rarely lives up to any of the commitments.**
 - **There is much lost trust between workers.**



Project Structure

TOCICO 2013 Conference

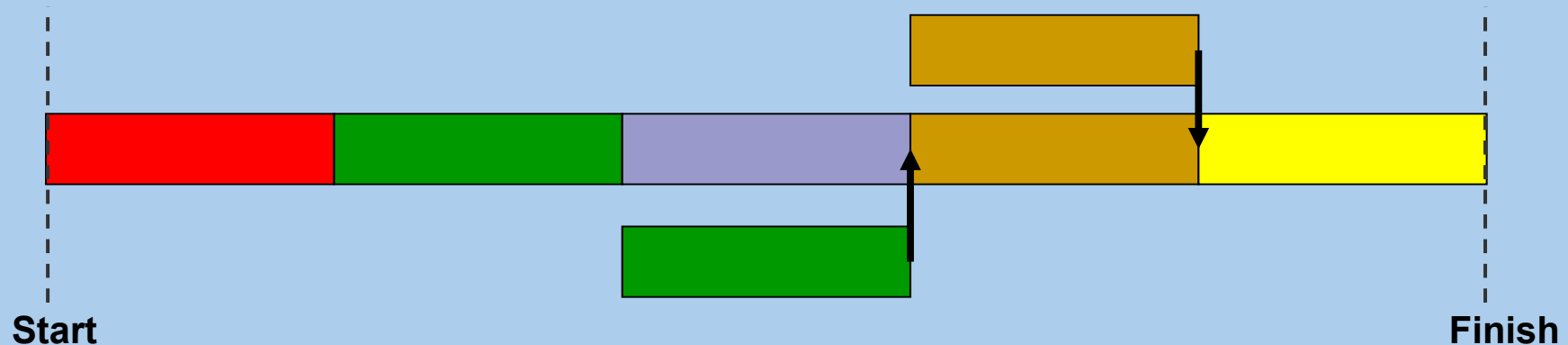

- **Projects have tasks that must be done in order (represented by the sequence of the boxes).**
- **Different resources perform each task (represented by colors).**
- **Sometimes parallel paths exist which must be completed before a task can continue (represented by the arrows).**

Projects ...

TOCICO 2013 Conference

- **Take too long**
- **Usually late**
- **Over budget**
- **Why?**
- **Excuses**
 - **We don't have enough safety!**
 - **Wasn't enough time.**
 - **Couldn't finish everything.**
 - **Wasn't enough money.**

**How long have people
been trying to fix this?**

**Can there be a
simple solution?**

Let's play a game!

The Nature of Tasks

The Sixes Game

TOCICO 2013 Conference

- **Given a fair die, ...**
- **How many rolls does it take to get a six?**

- **One roll?**
- **Six rolls?**
- **More than six rolls?**

- **Let's see!**

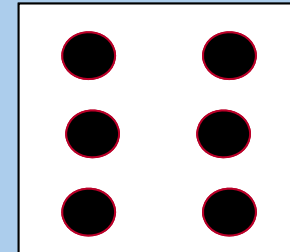

Probability of Rolling Six in Exactly N Rolls

TOCICO 2013 Conference

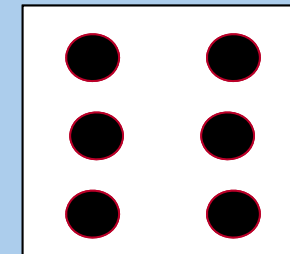
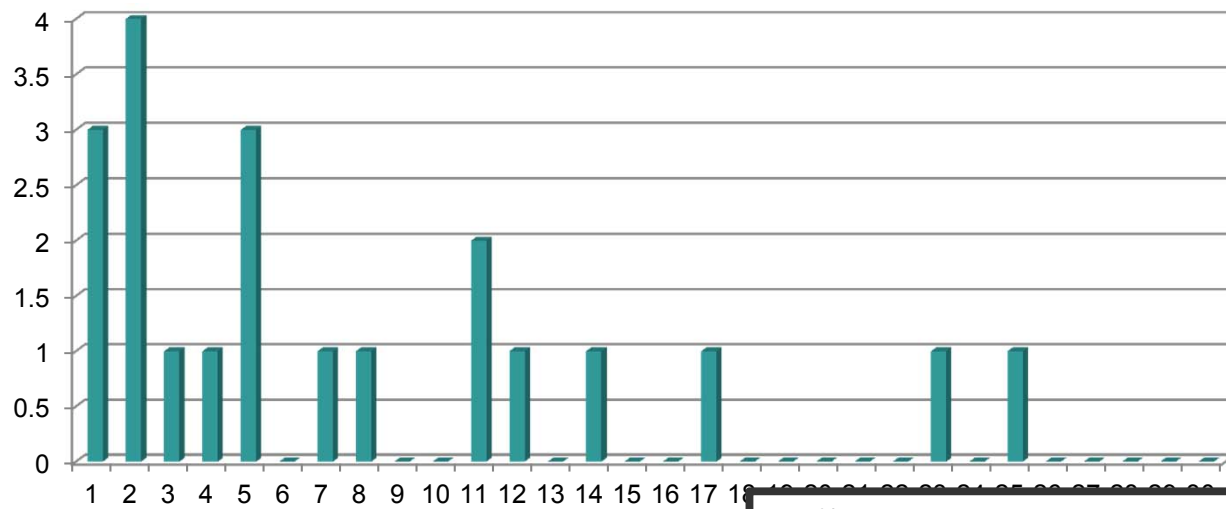

$$P(6 \text{ on the } N\text{th roll}) = \frac{1}{6} * \left(\frac{5}{6}\right)^{(N-1)}$$

A negative exponential!

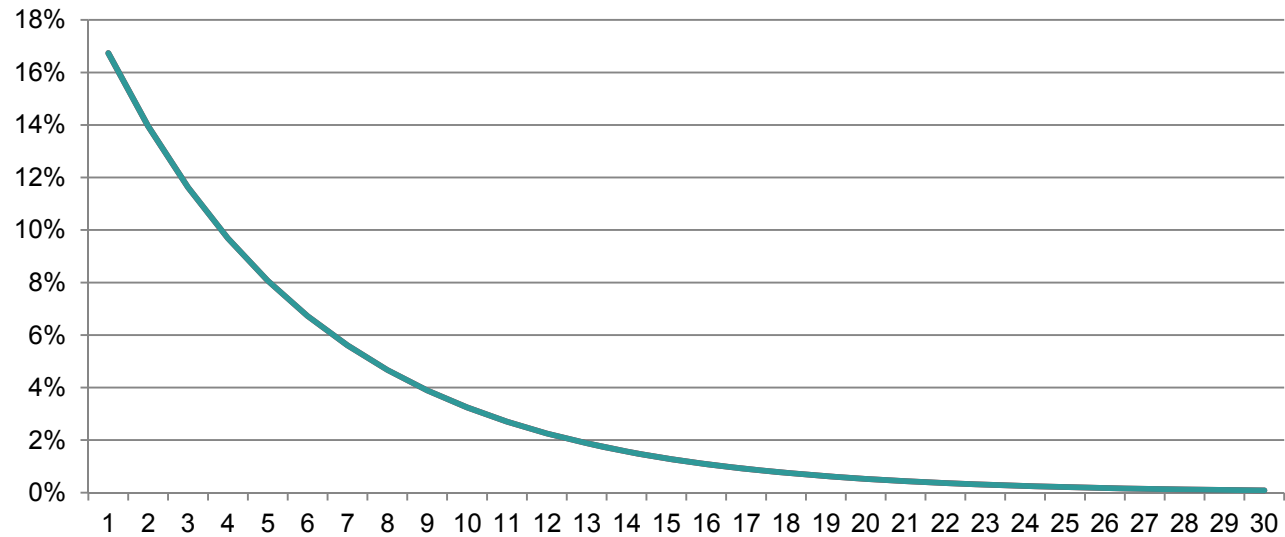

Normalized Expectation of Success

TOCICO 2013 Conference

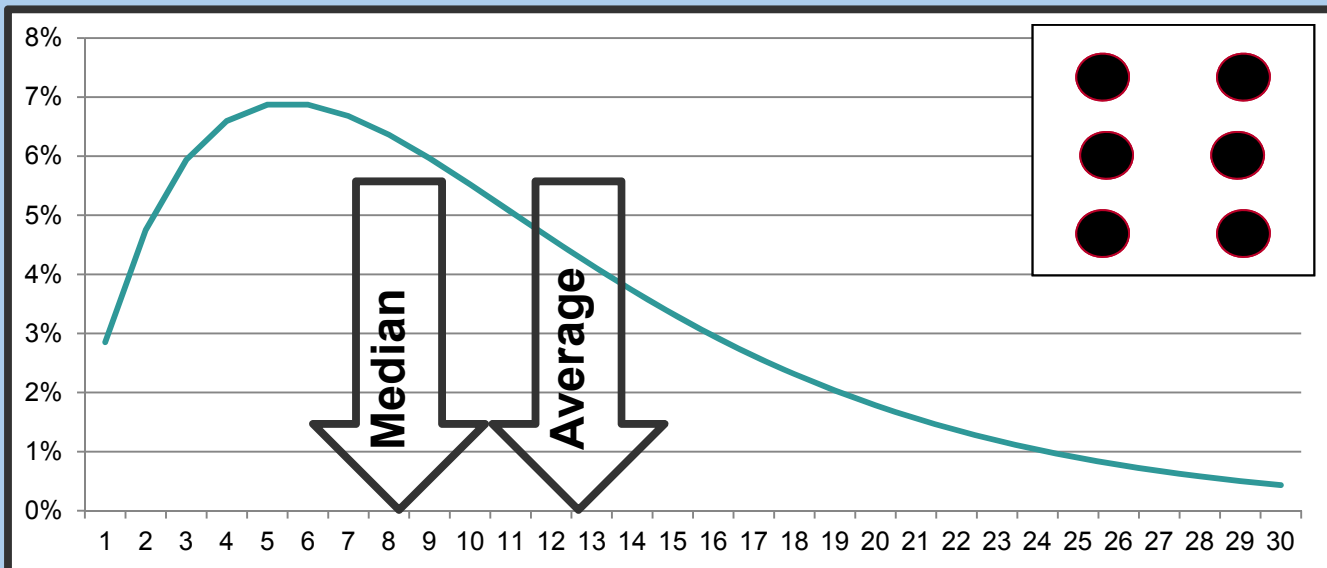

Probability Density Function.
The Normalized Probability of Rolling a Six (most of the time expect between 3 and 12 rolls)

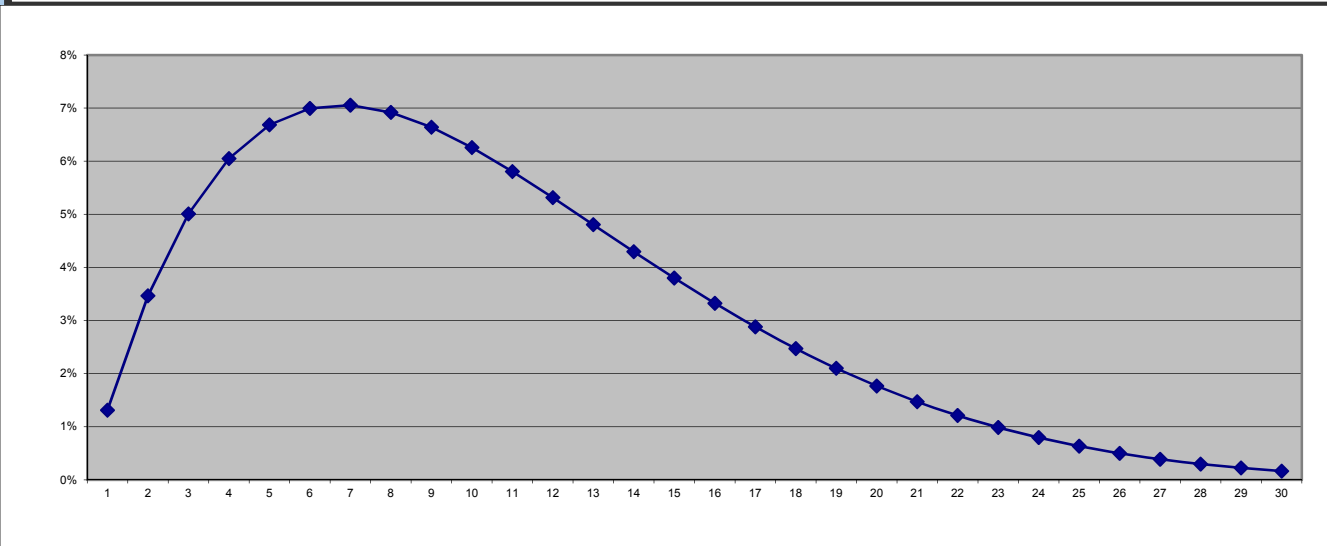

Beta Distribution
 $\alpha = 2$
 $\beta = 8$
Lower = 0
Upper = 50

Important! Cumulative Probability to Get a Six

TOCICO 2013 Conference

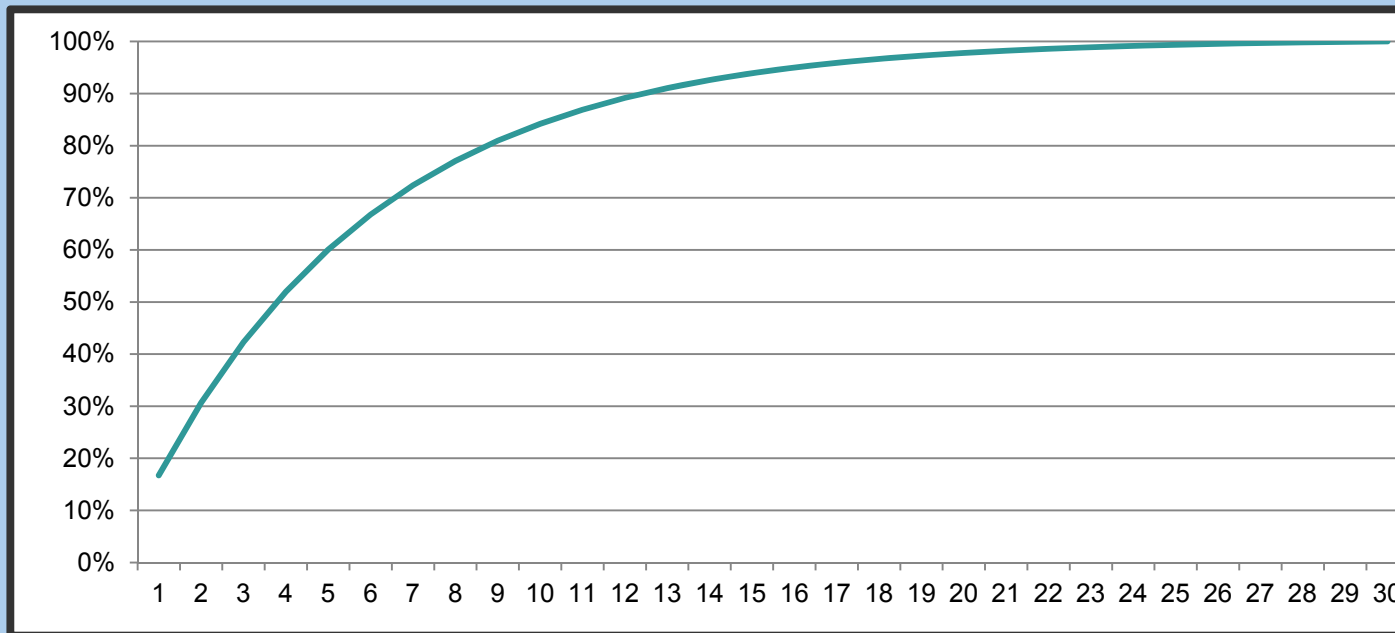

50%
(4)

95%
(18)

You are a contractor. You tell me when you will finish.

Your process follows a Sixes Distribution. If you complete on-time, I will pay you 100% of the contract amount.

If you are late, I will pay you only 50% and never contract with you again.

What is your Bid? How many rolls will it take to complete the contract?

Big Project with Ten Contractors

TOCICO 2013 Conference

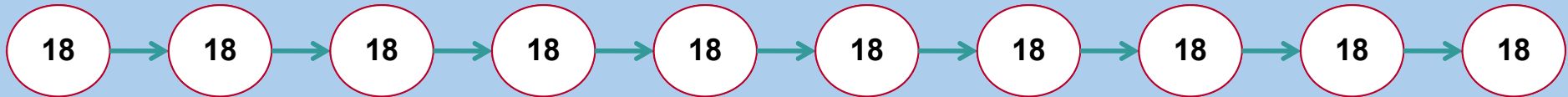

- If each of ten contractors bid on taking 18 days to deliver (95% safe) ... ?
- The time to deliver is 180 days.
- Each contractor acts to protect themselves (to deliver to their promises—to be ethical).

Do we recognize that employees in the project world are really just internal contractors?

Big Project with Ten Contractors (Employees)

TOCICO 2013 Conference

Before Each Task Estimated at 95% Safety Duration

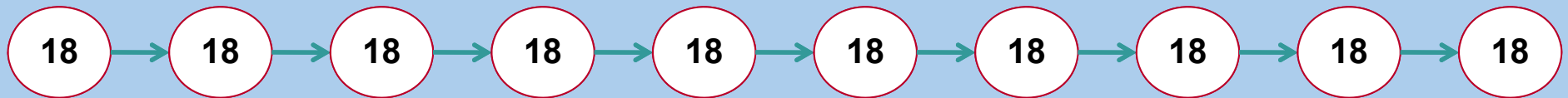

Aggressive Task Estimate (Cut 95% estimate in half)

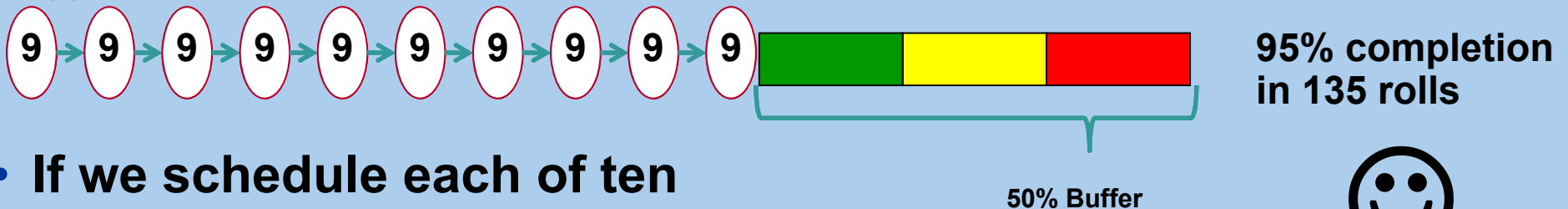

- If we schedule each of ten contractors 9 days aggressively...
- The project duration too aggressive at 90 days.
- But, if we add back 50% of the individual safety that we removed $[(180 \text{ rolls} - 90 \text{ rolls}) * 50\% = 45 \text{ rolls}]$, then $90 + 45 = 135$ and a 95% on-time delivery!



Try it! You'll like It!

Dealing with Parallel Tasks

TOCICO 2013 Conference

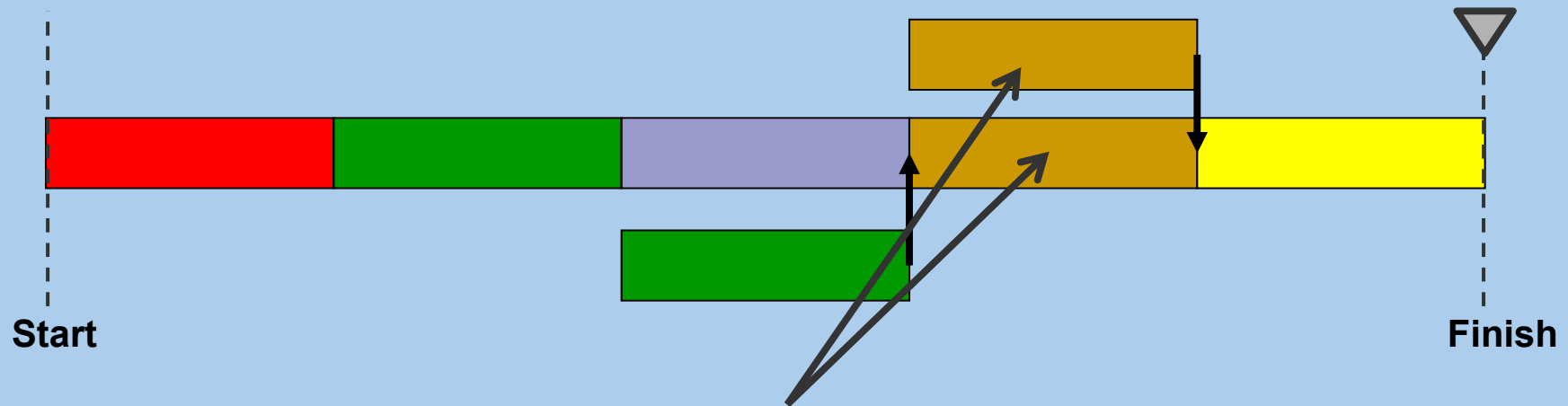

- In this simple project, the brown resource is scheduled to do two things at the same time.
- Can people be in two places at once?
- Can they do two things at the same time?
- Let's play another game!

The Behavior of People

Paper Tearing Game (a Timed Event)

TOCICO 2013 Conference

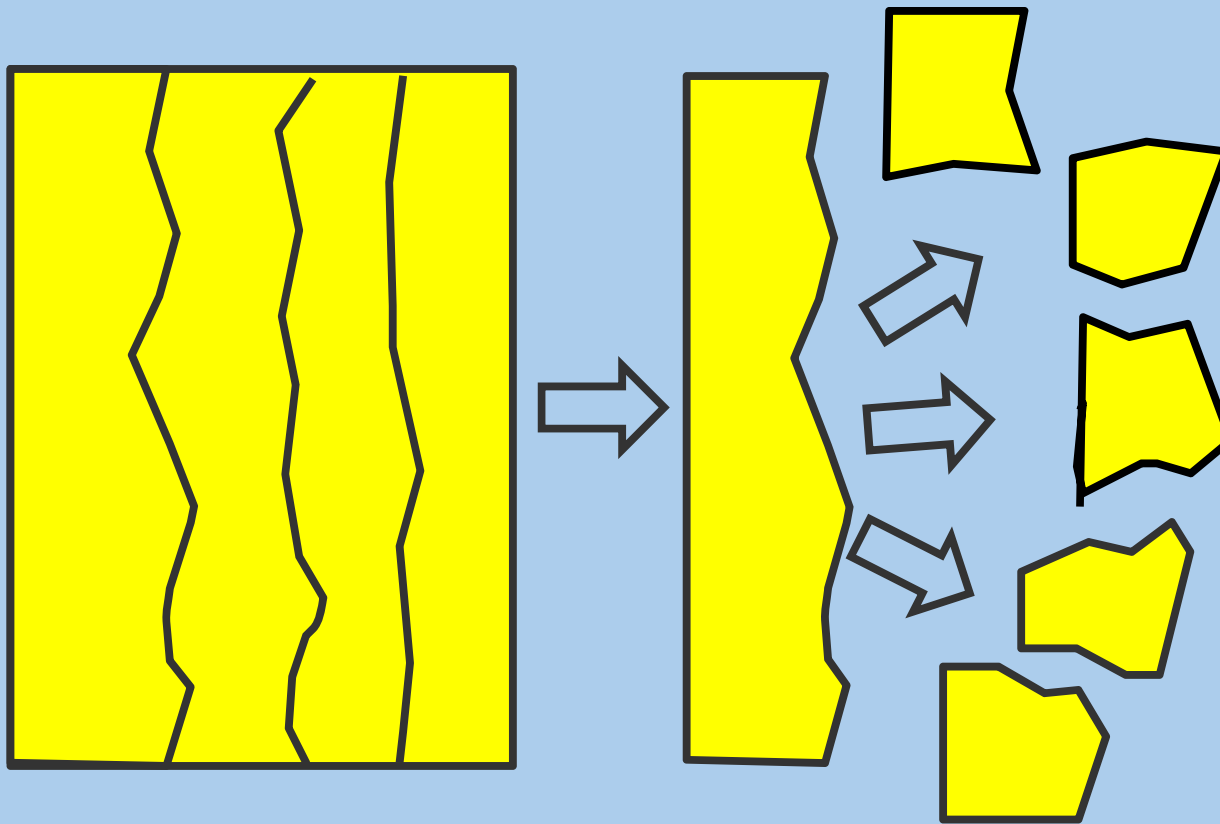

Tear paper into four vertical strips (making three vertical tears). Then tear each strip into five smaller pieces (tear horizontally four times). In the end, you should have 20 small pieces.

Do this with two pieces of paper of different colors.

The first time, you will multi-task. You can only make two tears on one color of paper.

Then you must switch to the other color paper and make two tears.

Then switch back to the first paper and make two tears.

And so on, until both papers are torn into 20 pieces.

The second time, do NOT multi-task. Tear one colored paper into 20 pieces and then tear the next colored paper into 20 pieces.

Number, Letter, Shape Game

TOCICO 2013 Conference

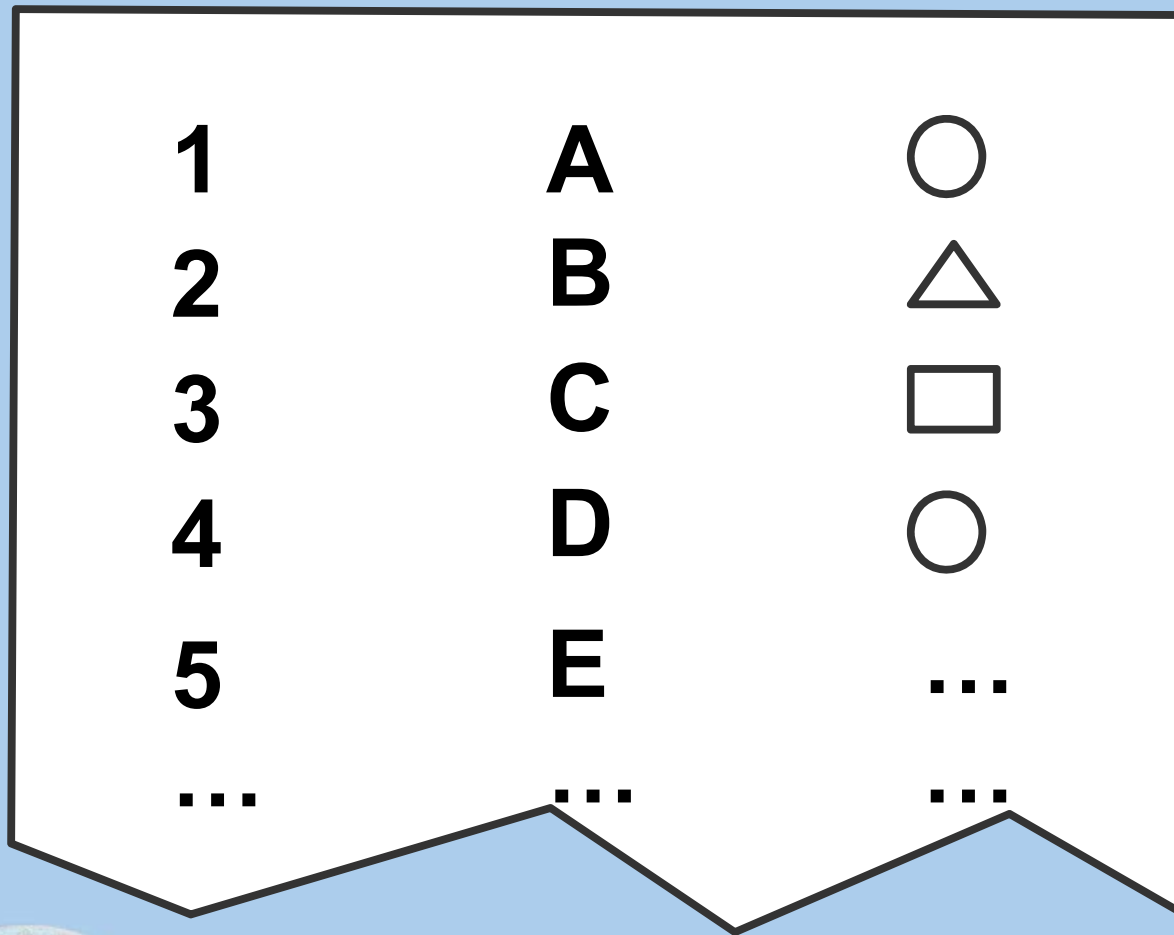

On a single sheet of paper, create three columns.

In the first column, will be the numbers 1 through 26.

In the second column, will be the letters A through Z.

In the third column, will be the repeating shapes of Circle, Triangle, Square.

First, fill the paper one row at a time.

The first row is 1, A, Circle.

The second row is 2, B, Triangle.

The third row is 3, C, Square.

Continue until all 26 rows are completed.

Second time, fill the paper one column at a time.

This is a timed event.

With Many Tasks: The Politically Correct Response

TOCICO 2013 Conference

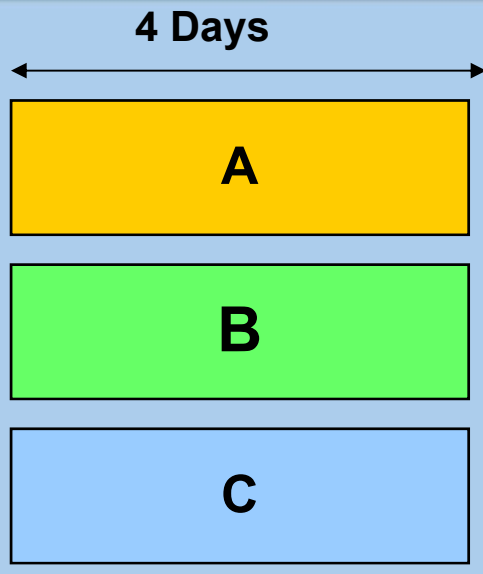

When you have 3 tasks that should take 4 days each, we have about 12 days of work to do. Working a little on each one shows progress on all tasks 😊. All the tasks are finished in about 12 days (plus a little set-up time).

What is the problem?

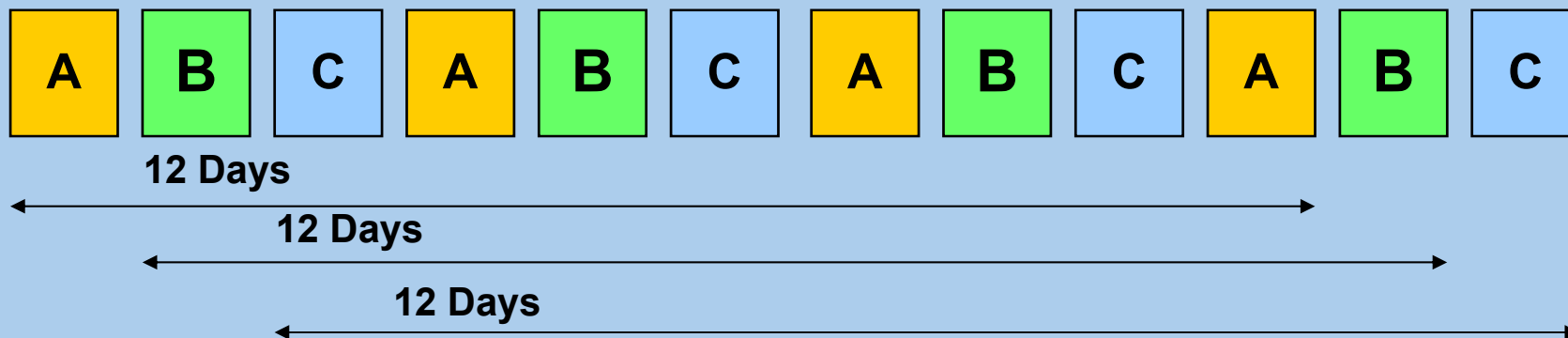

So, We Estimate our 4 Day Tasks as ...

TOCICO 2013 Conference

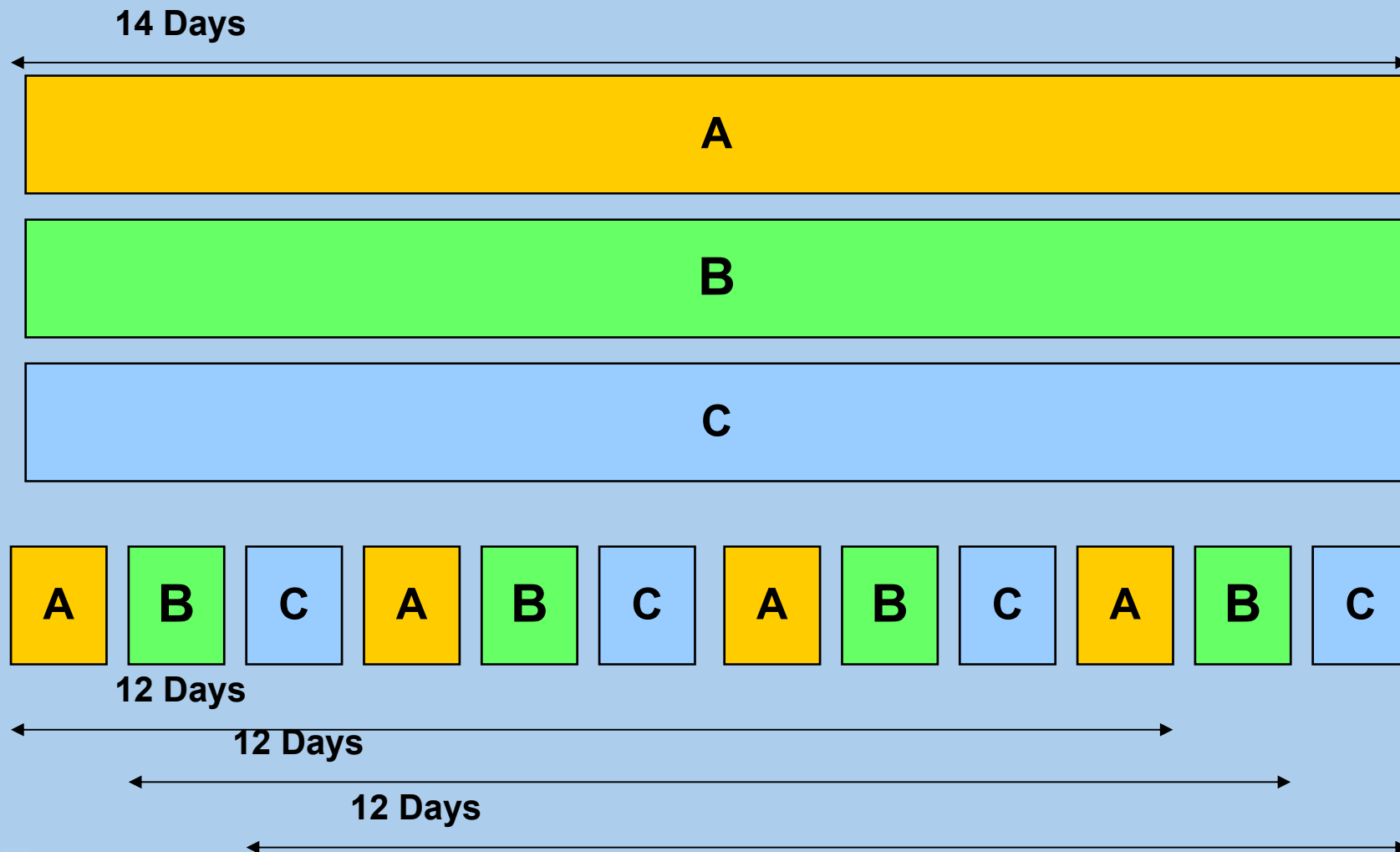

Multi-Tasking is 'The Norm'

TOCICO 2013 Conference

- How many times a day do you receive a phone call?
- How many emails do you receive each day?
- Do you talk with other people during the day?

What percentage of phone calls, emails and conversations are direct discussions about the ONE, MOST IMPORTANT task of the day?

If you are spending more than 40% of your time on the ONE IMPORTANT task each day, you are a very focused person.



Student Syndrome (Engineering Optimism)

TOCICO 2013 Conference

You have 14 days to do a 4 day task. When do you start?

**Or, are you a student with
other things on your mind?**

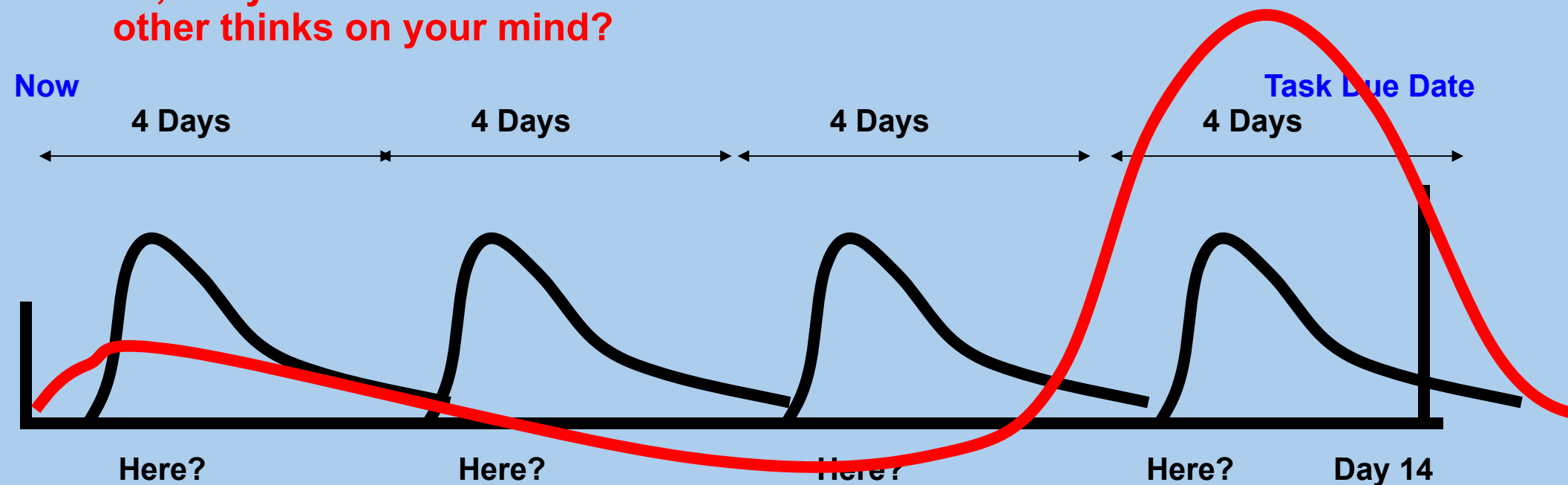

**Why not? I'm good!
I think I can do
a 4 day task in
only 2 days!**

Parkinson's Law

TOCICO 2013 Conference

And, if you do start early, when will you finish?
Do you turn in work early? Will you get enough time next time?
Or, maybe, you could just keep adding things to it!

Now

Task Due Date

4 Days

3 More Days

2 More Days

Or, maybe I should try something totally different.

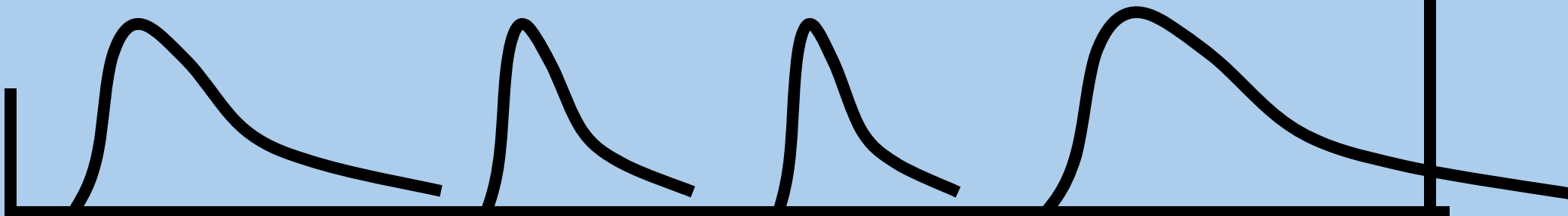

I could start early and end here.

“But. I want to think about this for a while.”

“Now, I have another Idea! The Task is not due yet. I’ll add my idea!”

Parkinson’s Law: **“Work expands to fill the time available.”**

Day 14

The Problems with Traditional Project Scheduling

Impact of the Physics of Projects and Human Behavior

TOCICO 2013 Conference

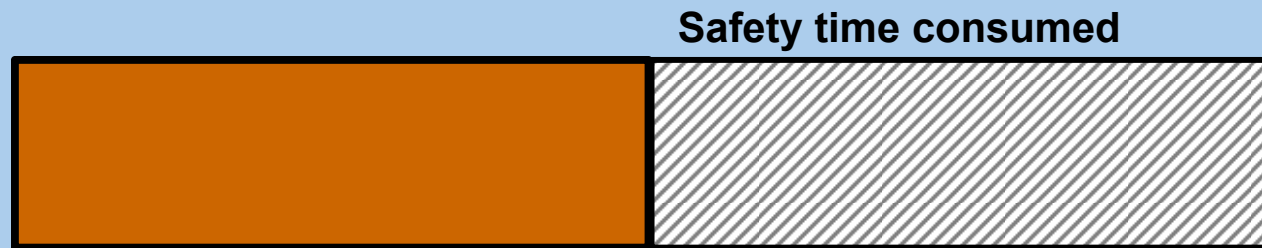

Parkinson' Law
(Use all the time available)

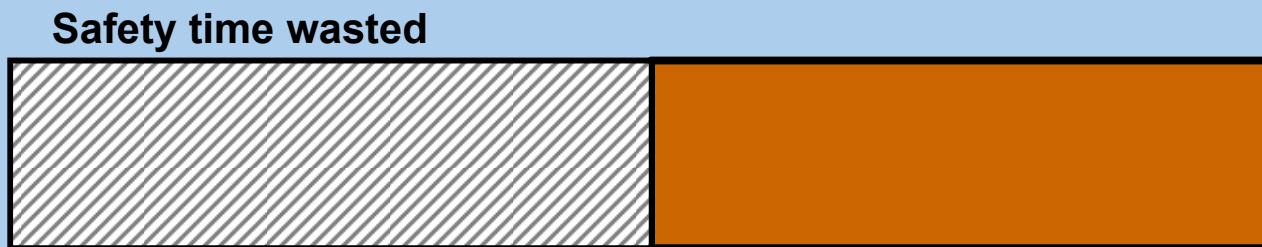

Student Syndrome
("It's not due until Friday!")

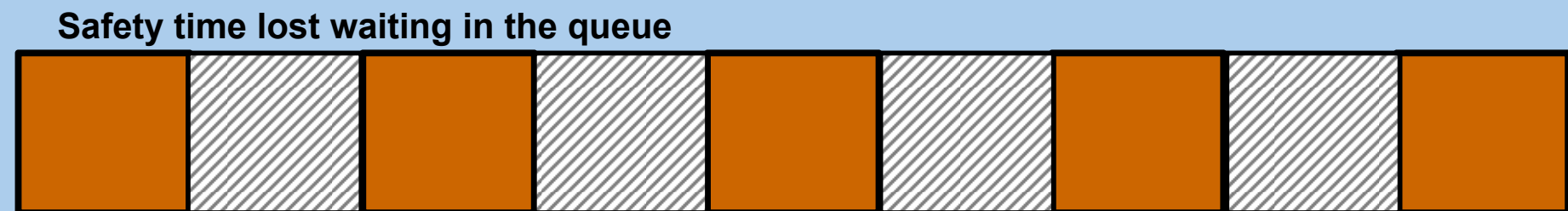

Bad Multi-Tasking (Task durations are multiplied by the number of simultaneous tasks. The impact is much, much worse, if mental energy is involved.)

Looking Close at Projects

TOCICO 2013 Conference

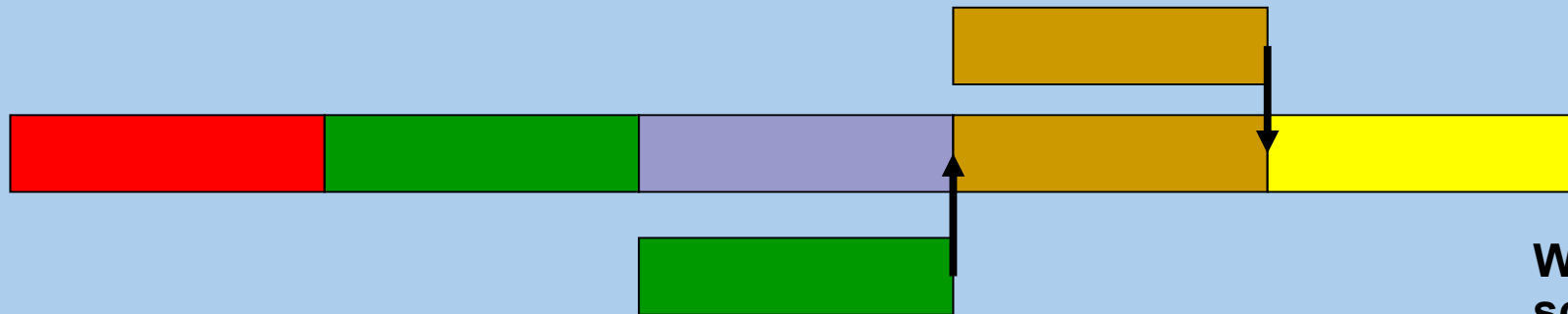

Critical Path-Longest Path of Tasks

We should not schedule conflict (don't cause bad multi-tasking).

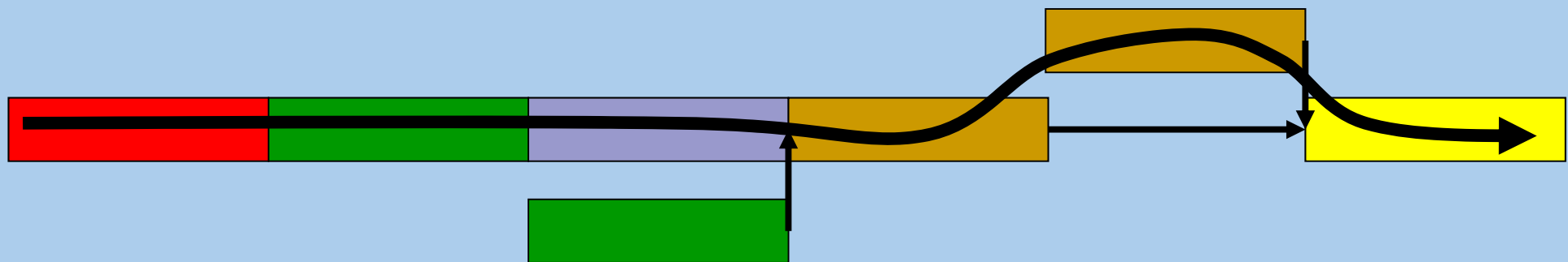

Critical Chain-Longest Chain of Tasks when Resources are Considered

Empirical Results of Projects

TOCICO 2013 Conference

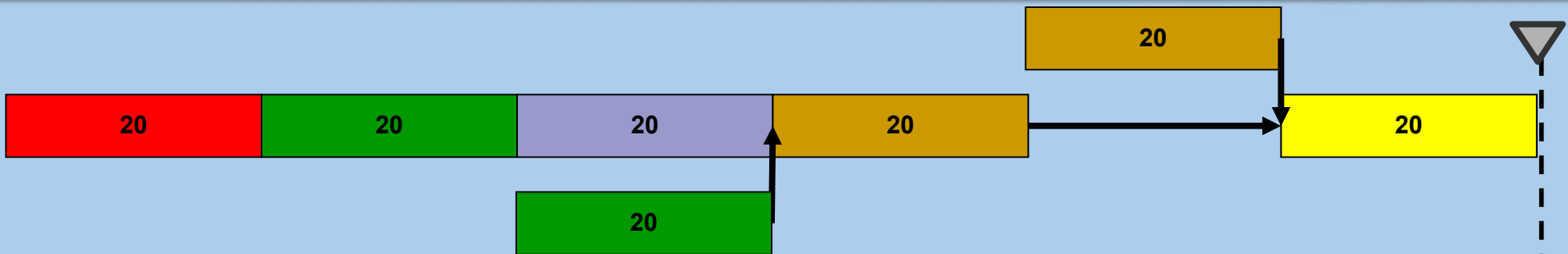

80% of tasks complete on-time.

95% of the time the projects are late.

Examples:

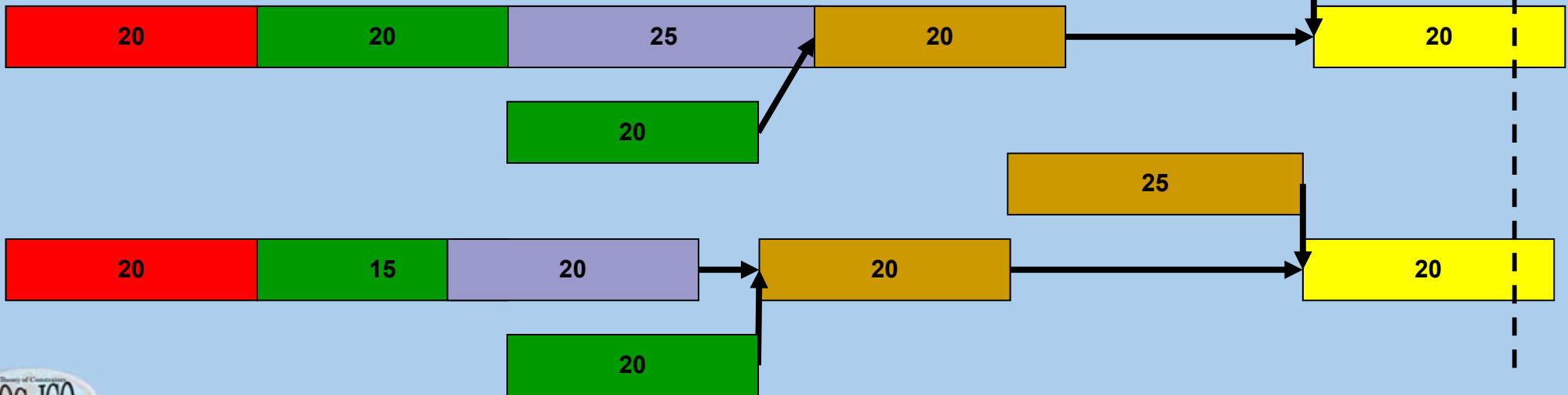

Critical Chain Project Management Scheduling

Elements of the Project Management Solution

TOCICO 2013 Conference

- **Focus on the Critical Chain.**
- **Remove Conflicts.**
- **Aggressive Scheduling** (use median estimates to remove the excess safety).
- **Insert Strategically Place Buffers.**
- **Eliminate Milestones.**
- **De-couple Non-Critical Chain Tasks** (use Feeder Buffers).
- **Communicate Time Remaining** (not “Percent Complete”).

Project Tasks

TOCICO 2013 Conference

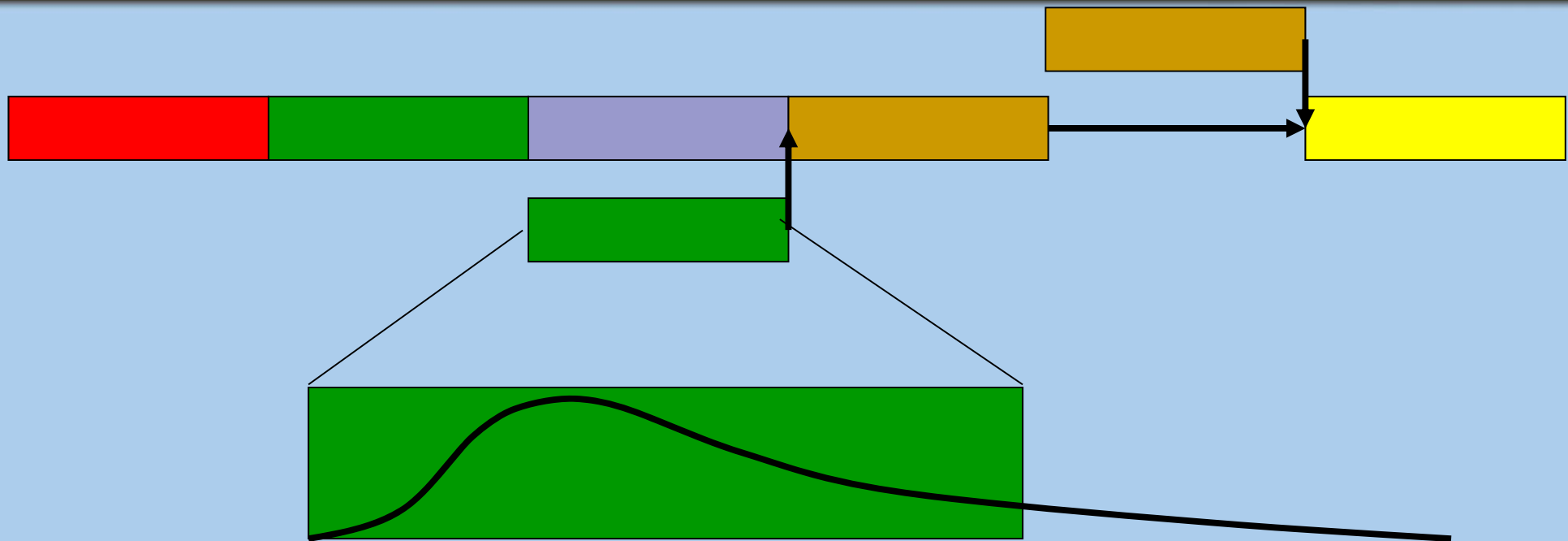

The Probability Distribution for individual tasks follows the Beta distribution.

**How long would it take you to paint your house?
What is the aggressive estimate?**

To be 90% sure, how long will it take?

Project Tasks

TOCICO 2013 Conference

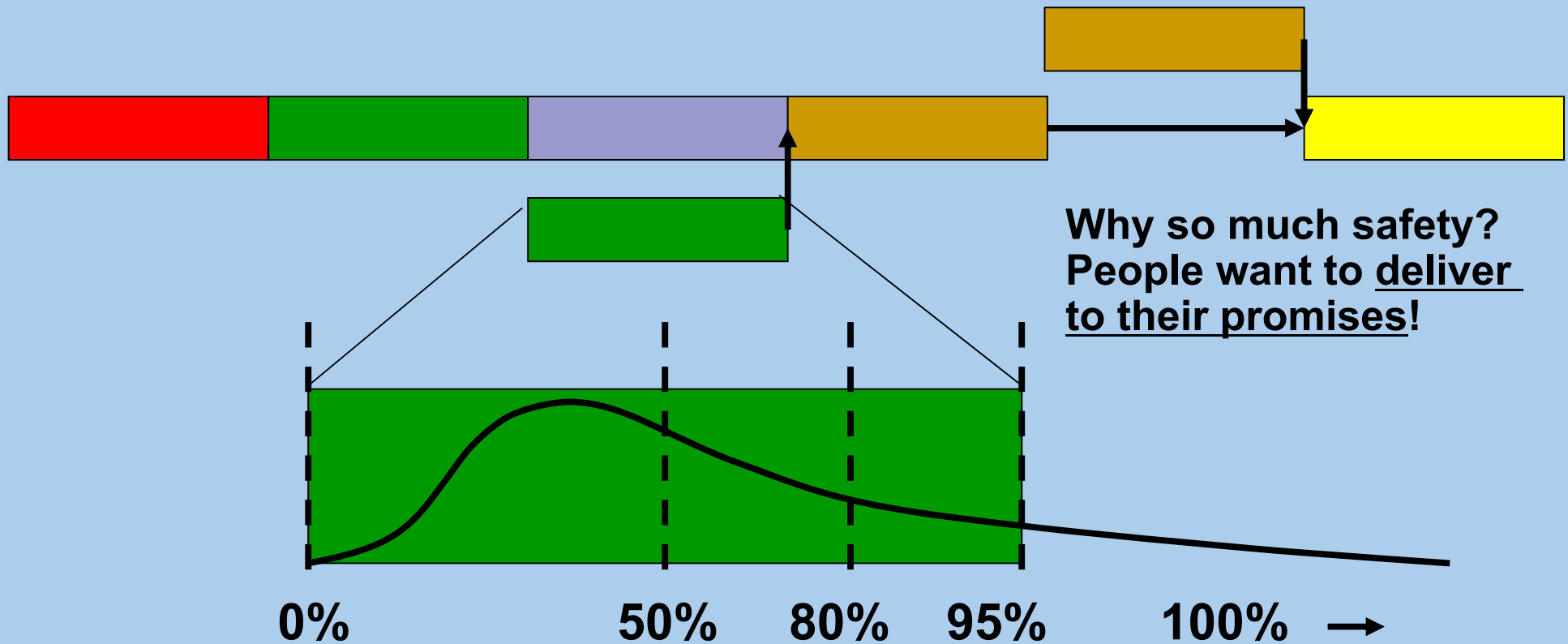

Probability of Completion at Time.

Half of project task duration estimate is safety from the known uncertainty in the estimate.

Solution for Projects

TOCICO 2013 Conference

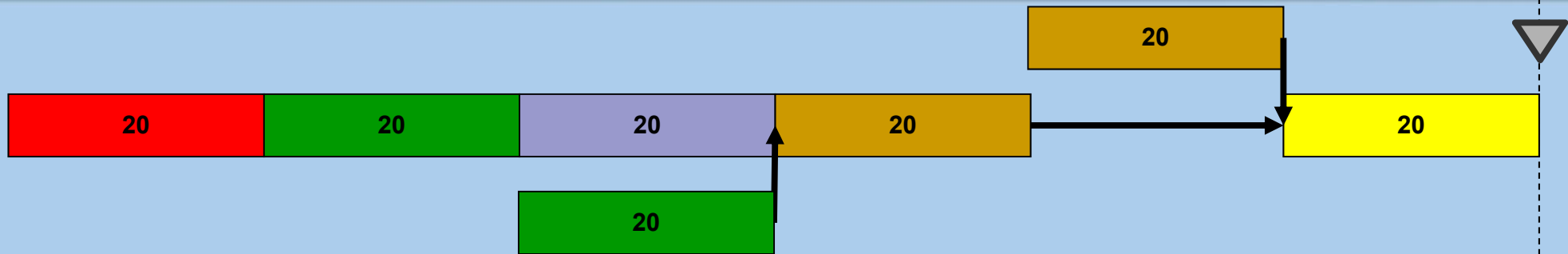

Don't Waste Precious Project Time along Critical Chain!

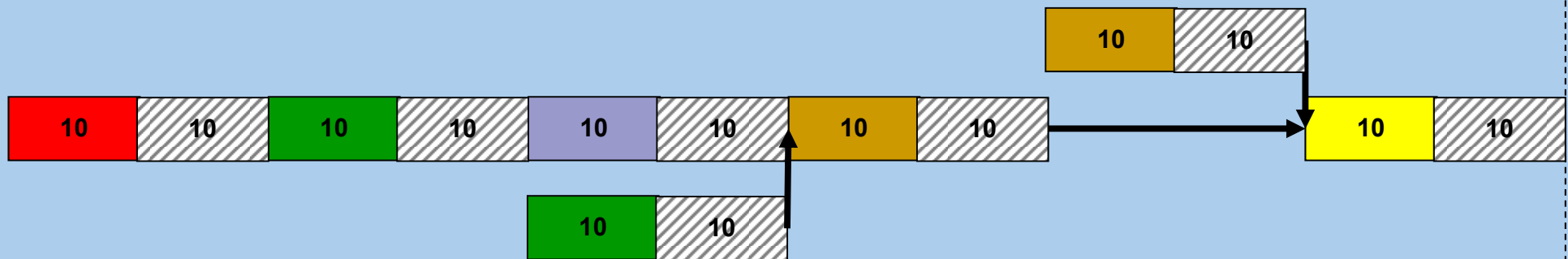

Half of Task Estimates are Individual Safety!

**“We are concerned about
COMPLETING THE PROJECT ON-TIME,
not necessarily the tasks on-time.”**

Move Excess Safety

TOCICO 2013 Conference

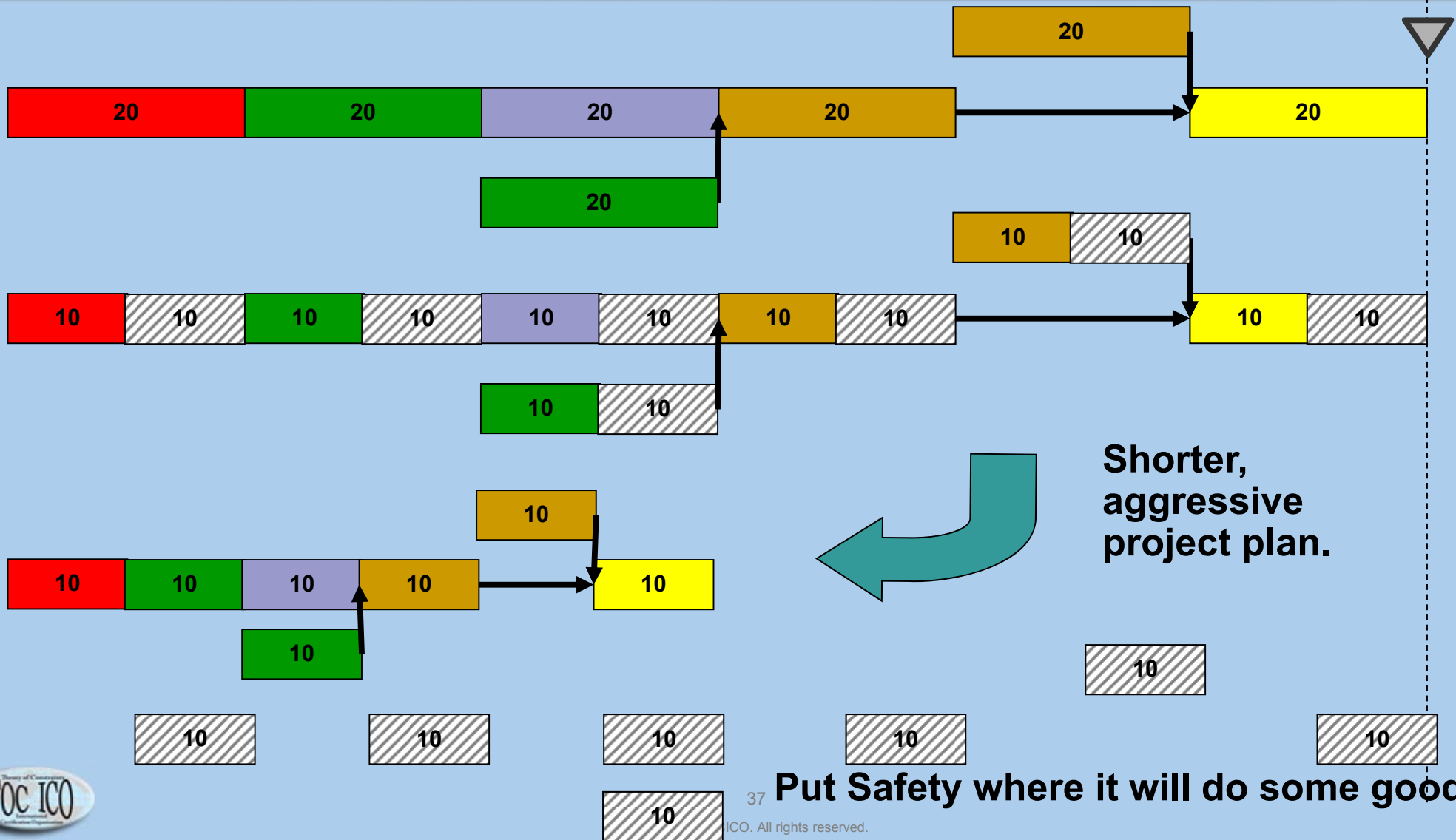

Add Strategic Safety



More Strategic Safety Needed

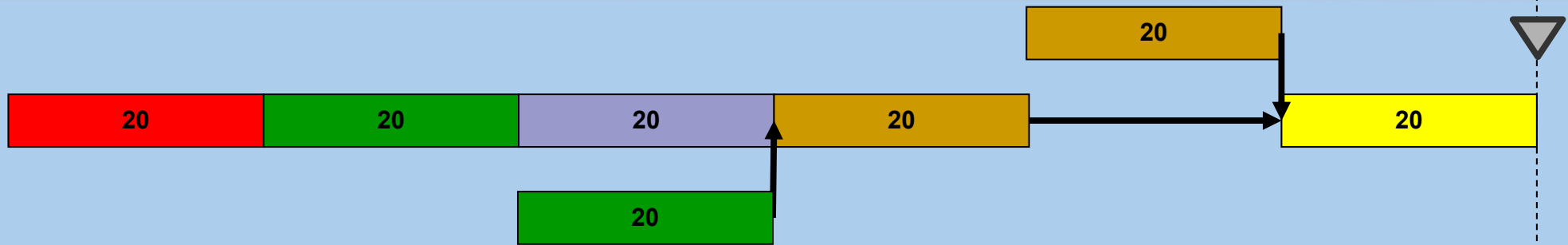

Need safety on Feeding Chains to avoid delaying Critical Chain.

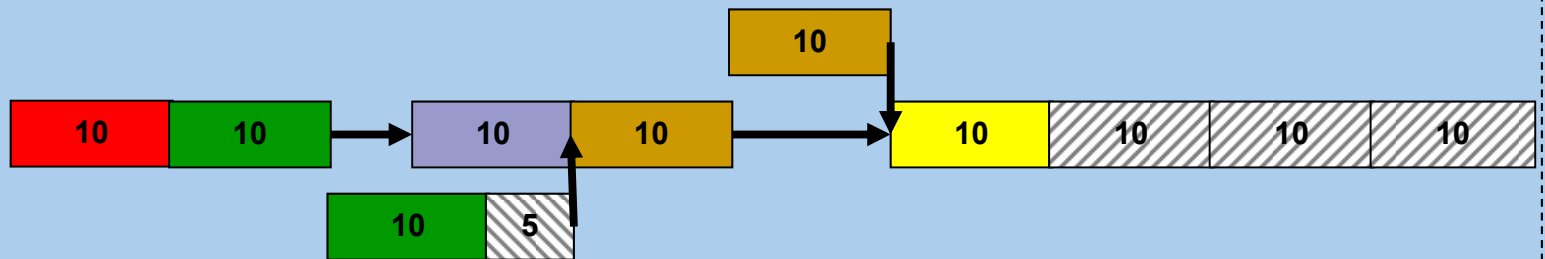
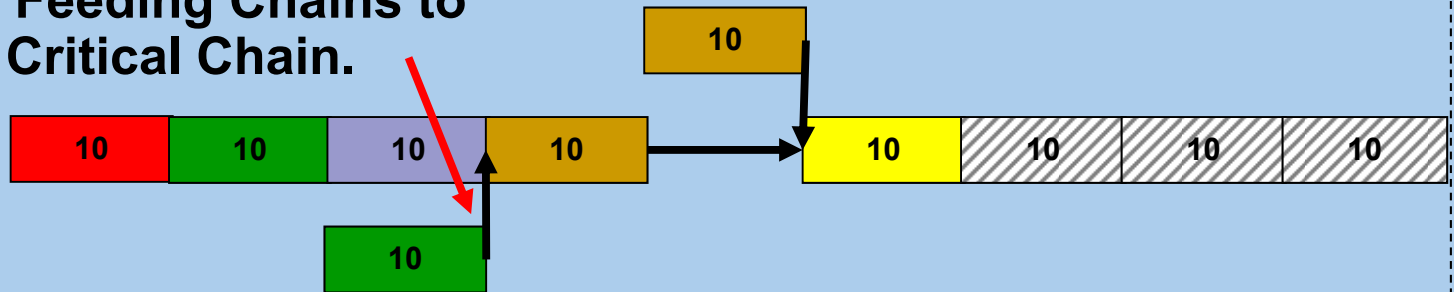

Results: Feasible Projects

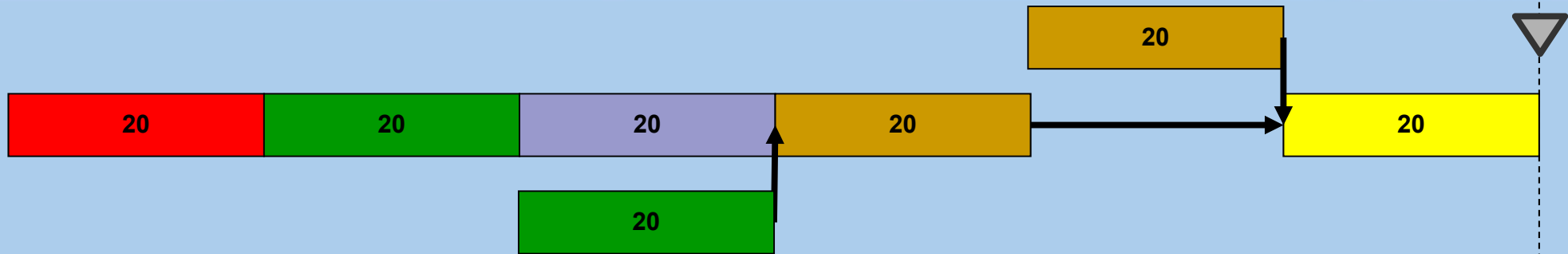

Traditional (Fat Projects) are Late 95%.

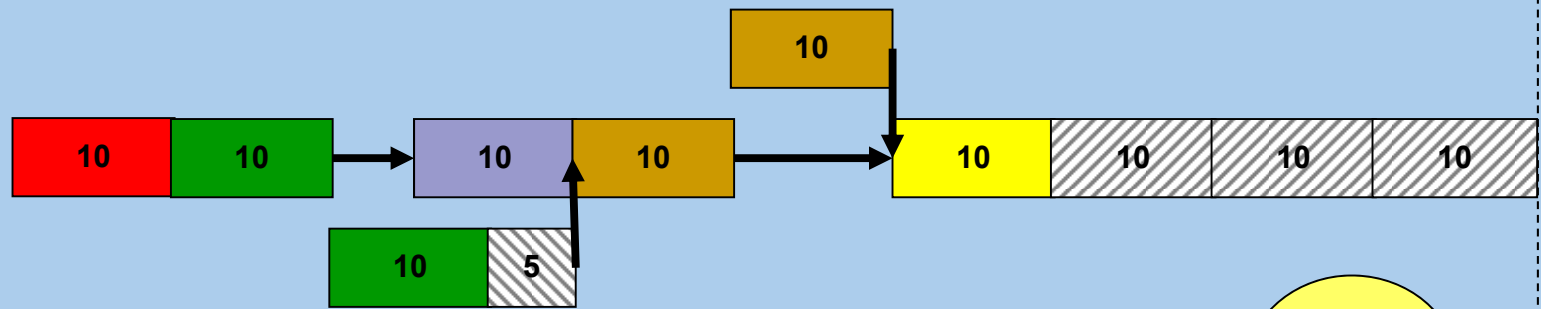

CCPM Schedules are shorter and on-time 95% of the time!

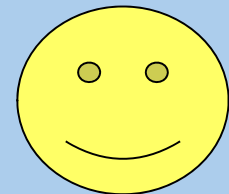

Managing Project Execution

Buffer Management Measures

Critical Chain Project Plan

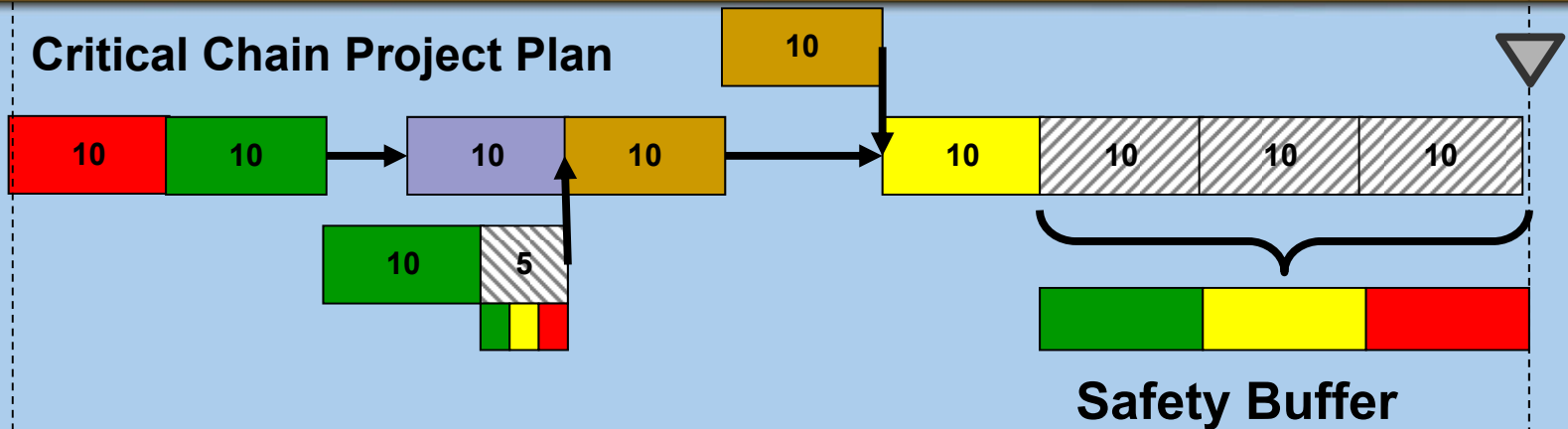

Example:

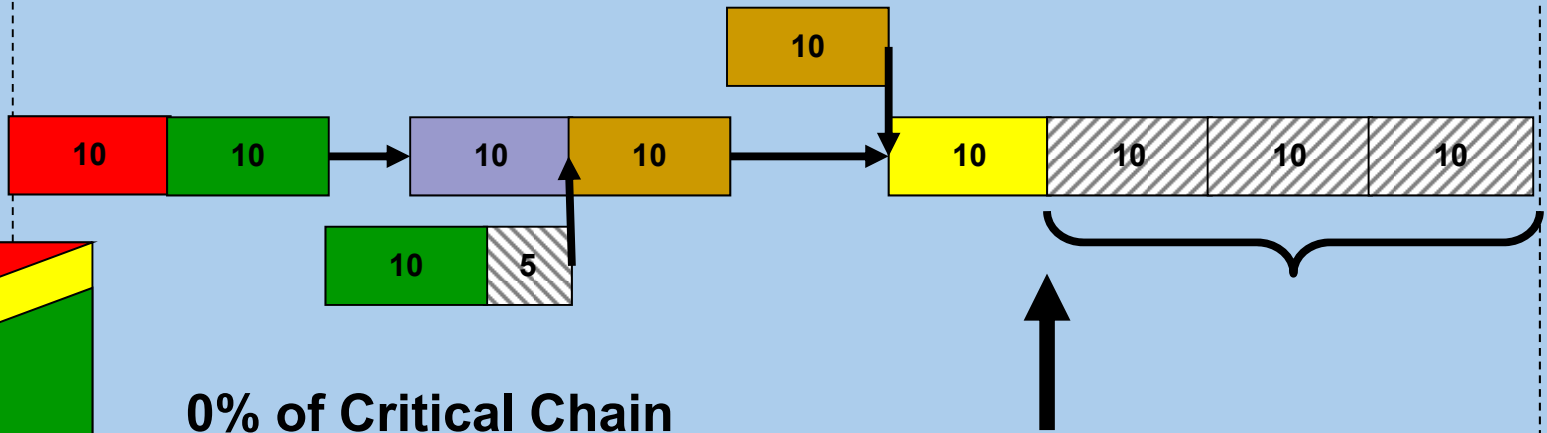

0% of Critical Chain Completed.
0% of Safety Consumed.
Are we in trouble?

Expected Completion

Today



Buffer Management Measures

TOCICO 2013 Conference

Critical Chain Project Plan

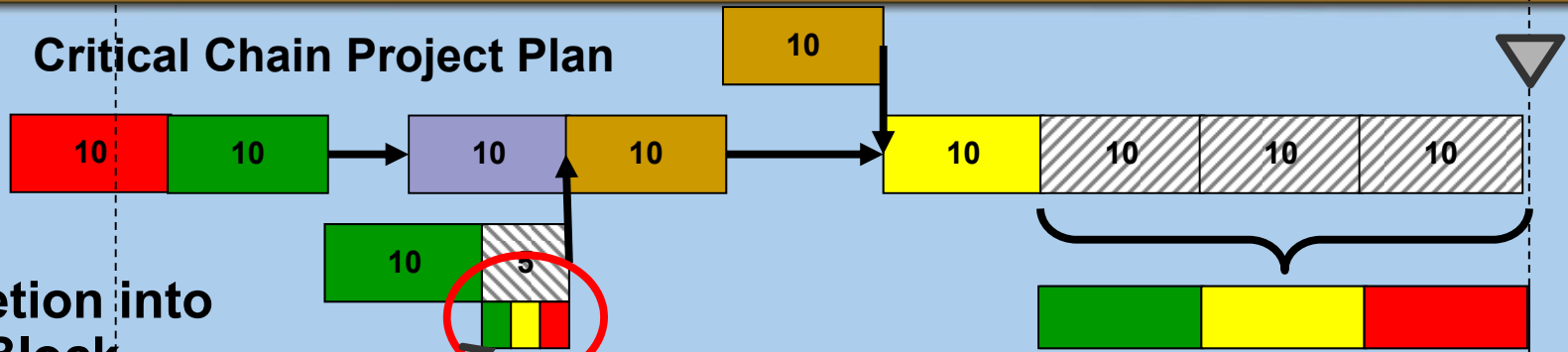

Safety Buffer

Penetration of Expected Completion into Strategic Safety Block (Project Buffer) is a "Leading Measure."

Example:

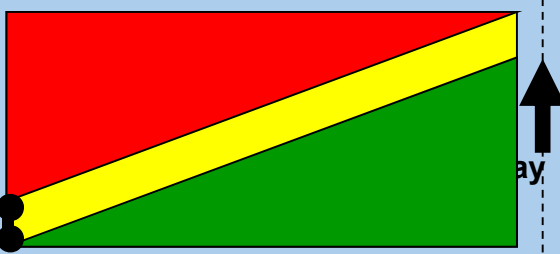
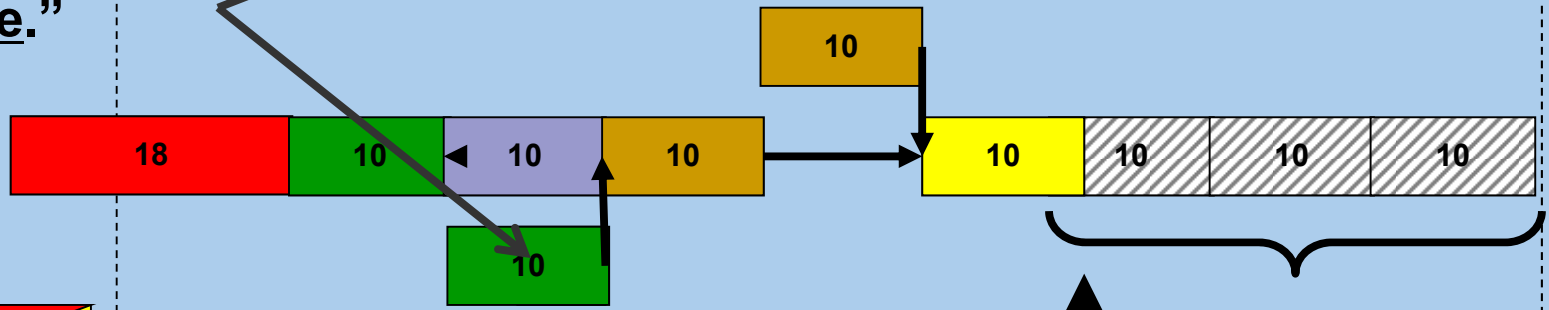

0% of Critical Chain Completed.
5% of Project Safety Consumed.
Are we in trouble?

Expected Completion



Buffer Management Measures

Critical Chain Project Plan

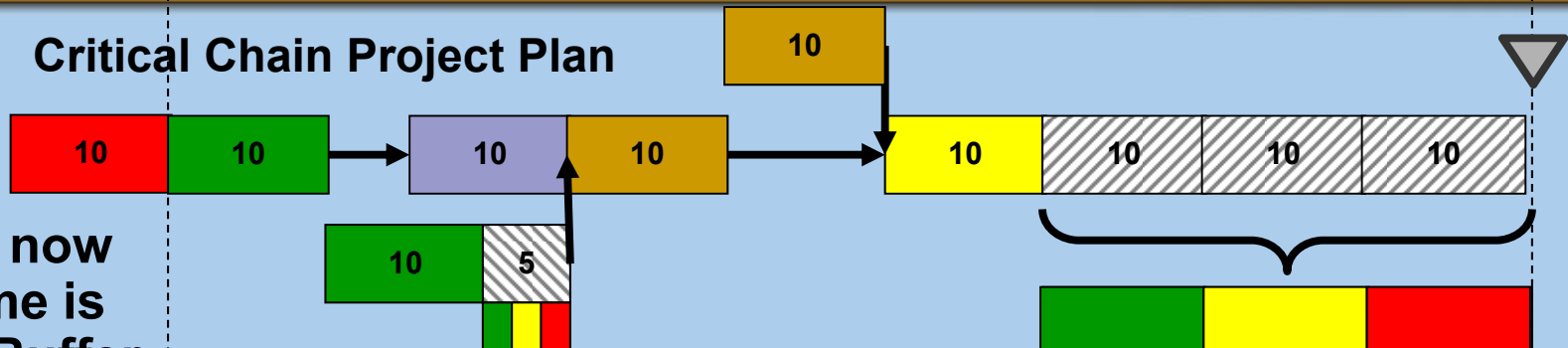

Safety Buffer

The red resource now estimates less time is needed. Project Buffer penetration is reduced!

Example:

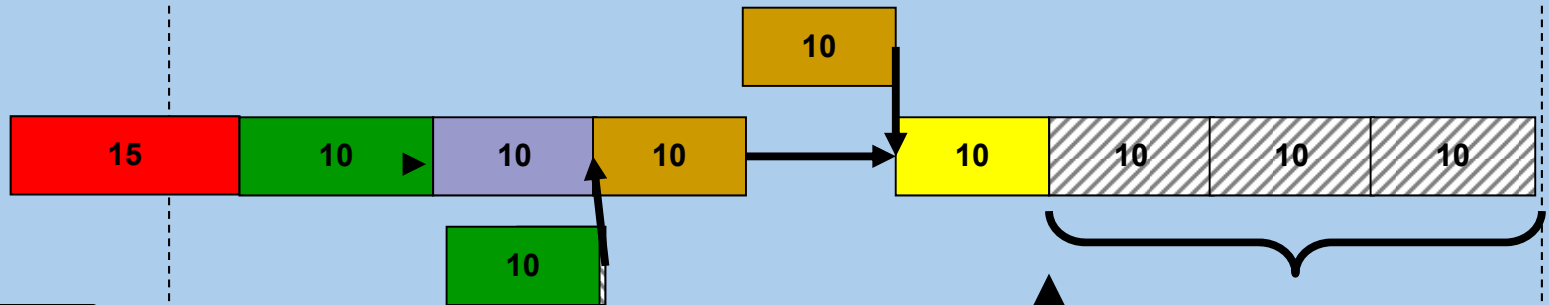

0% of Critical Chain Completed.

0% of Safety Consumed.
Are we in trouble?

Expected Completion

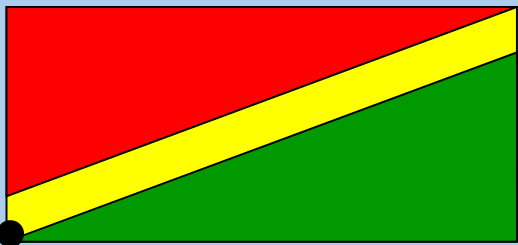

Buffer Management Measures

Critical Chain Project Plan

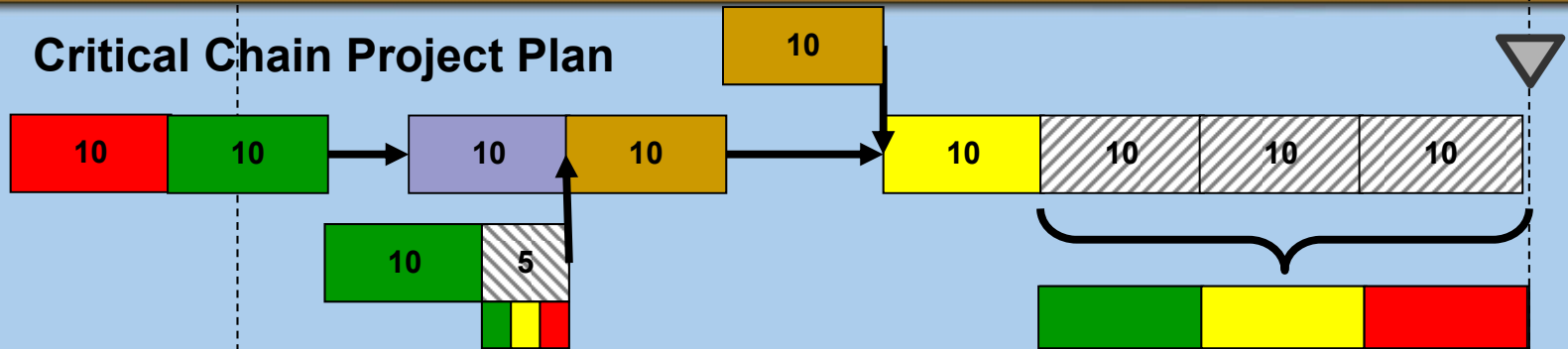

Safety Buffer



Example:

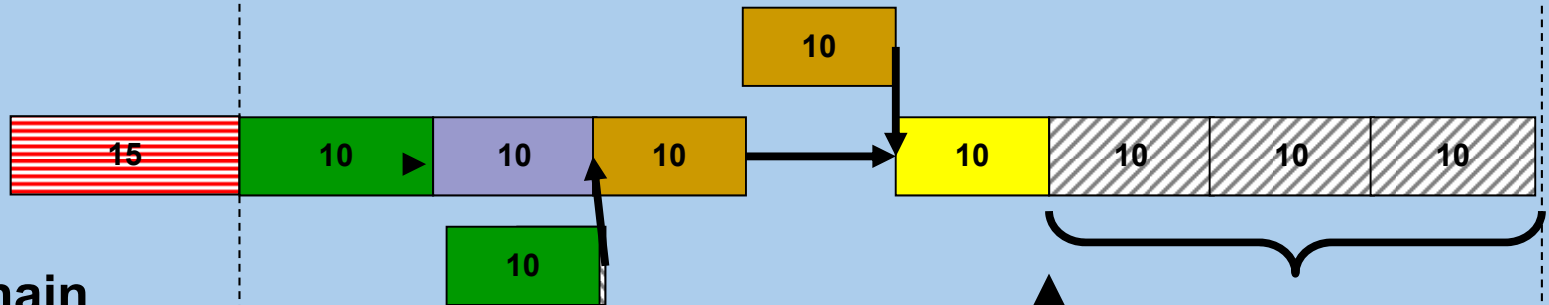

17% of Critical Chain Completed.
0% of Safety Consumed.
Are we in trouble?

Today

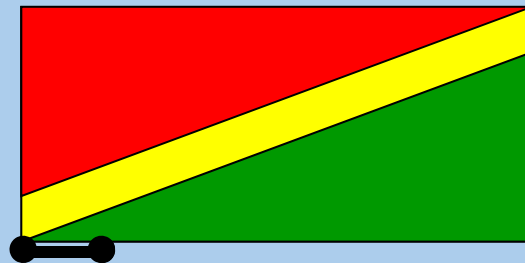

Expected Completion

Buffer Management Measures

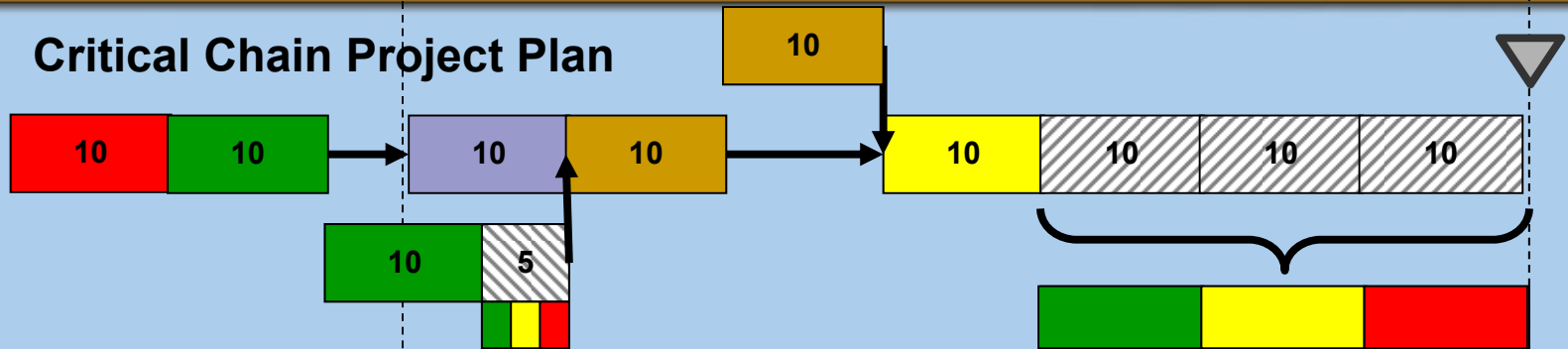

Safety Buffer

Example:

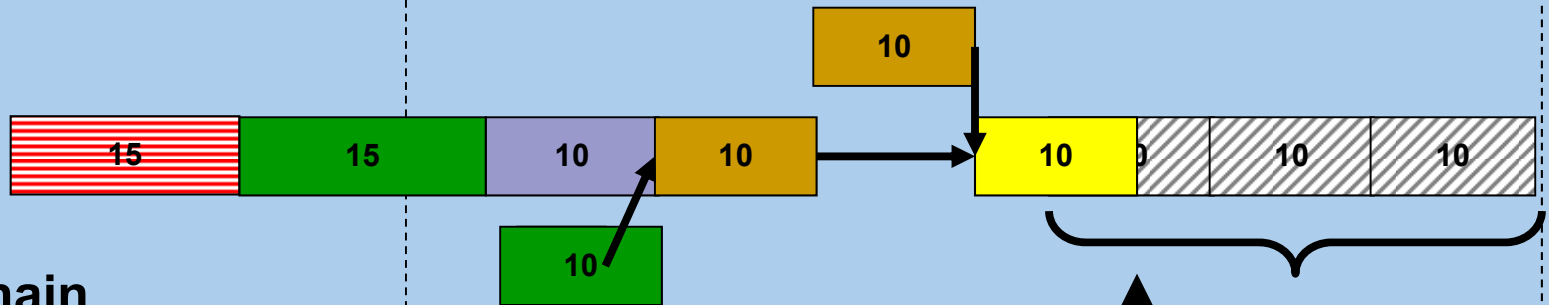

17% of Critical Chain Completed.
17% of Safety Consumed.
Are we in trouble?

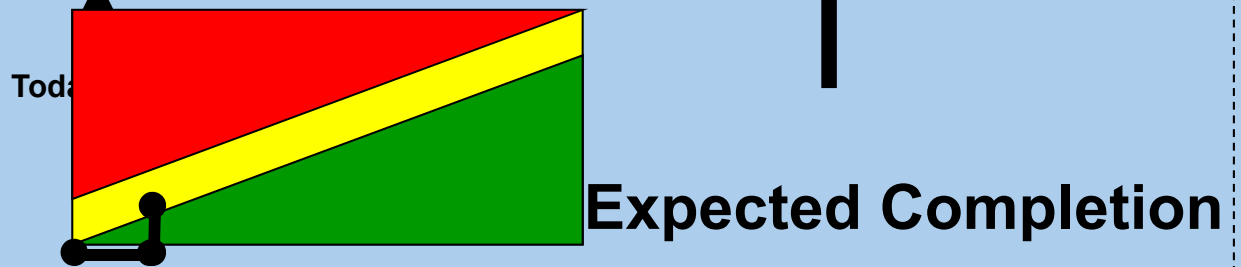

Expected Completion

Buffer Management Measures

Example:

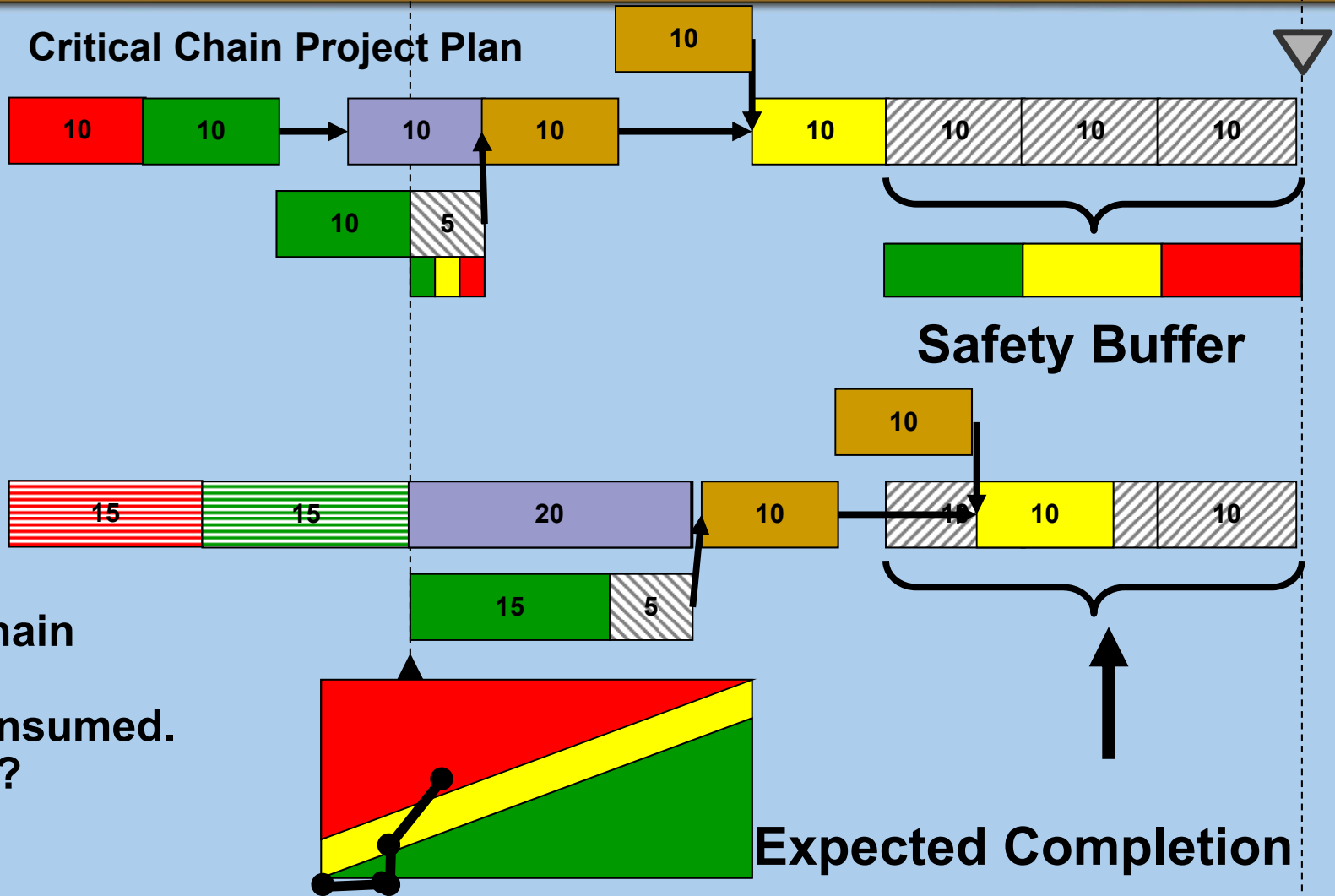

33% of Critical Chain Completed.
50% of Safety Consumed.
Are we in trouble?

Buffer Management Measures

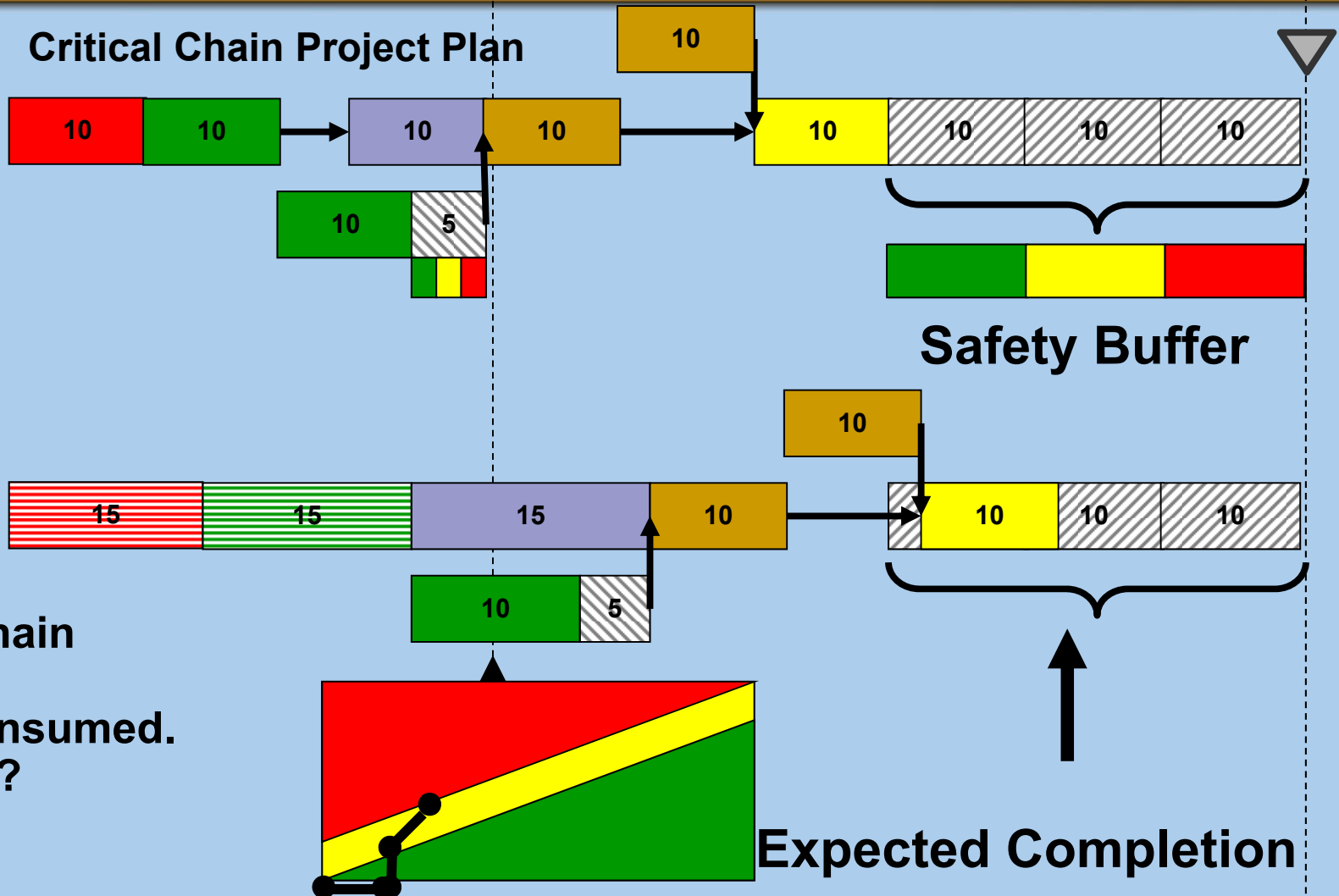

Example:

33% of Critical Chain Completed.
 40% of Safety Consumed.
 Are we in trouble?

Buffer Management Measures

Critical Chain Project Plan

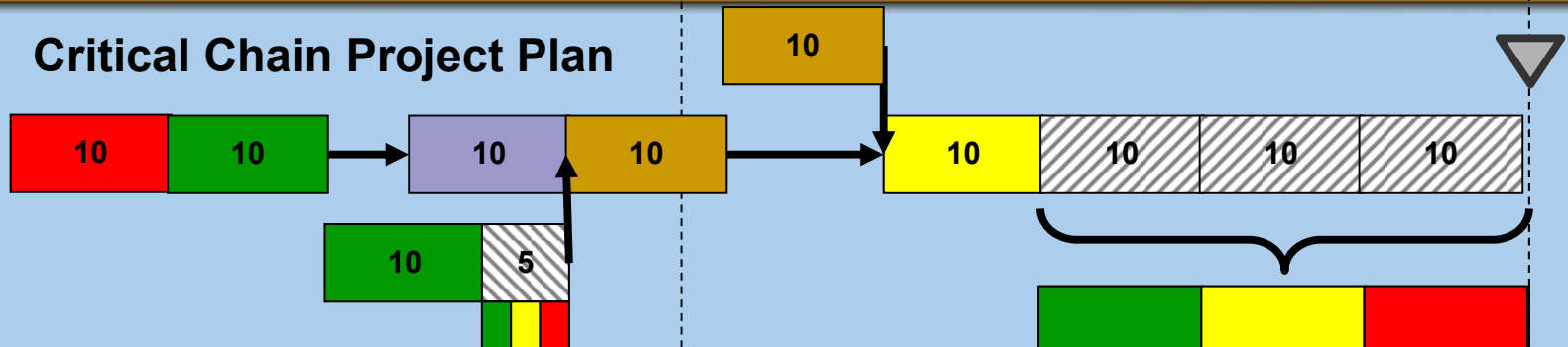

Safety Buffer

Example:

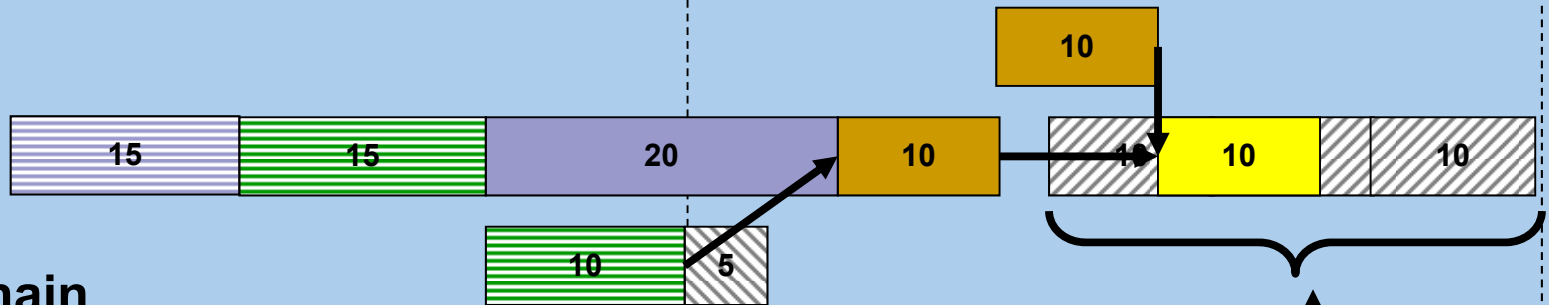

33% of Critical Chain Completed.
50% of Safety Consumed.
Are we in trouble?

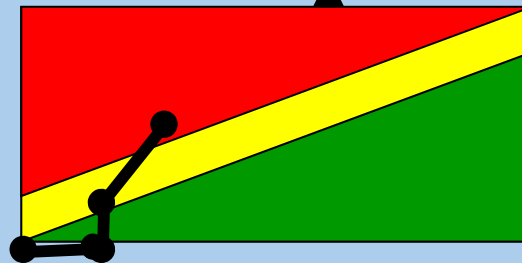

Expected Completion



Buffer Management Measures

Critical Chain Project Plan

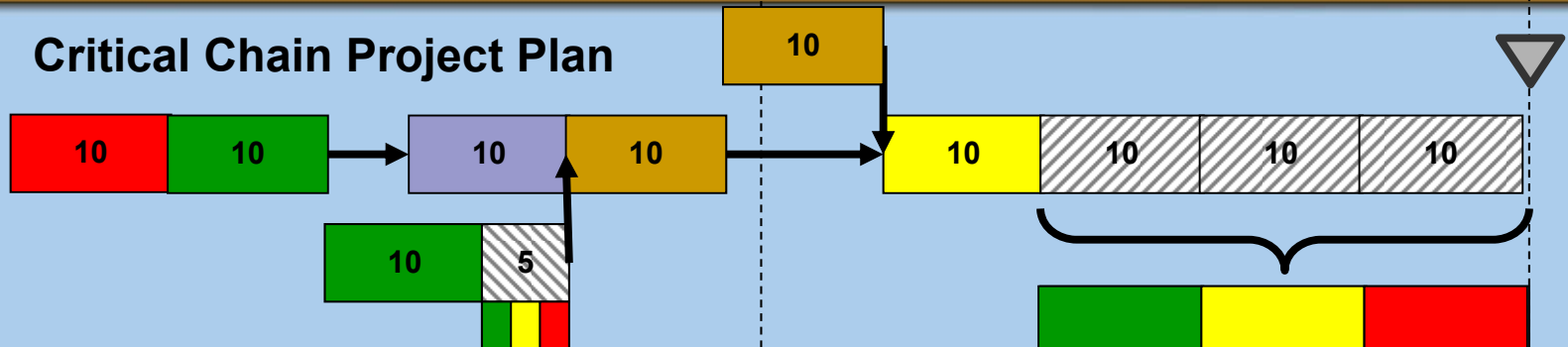

Example:

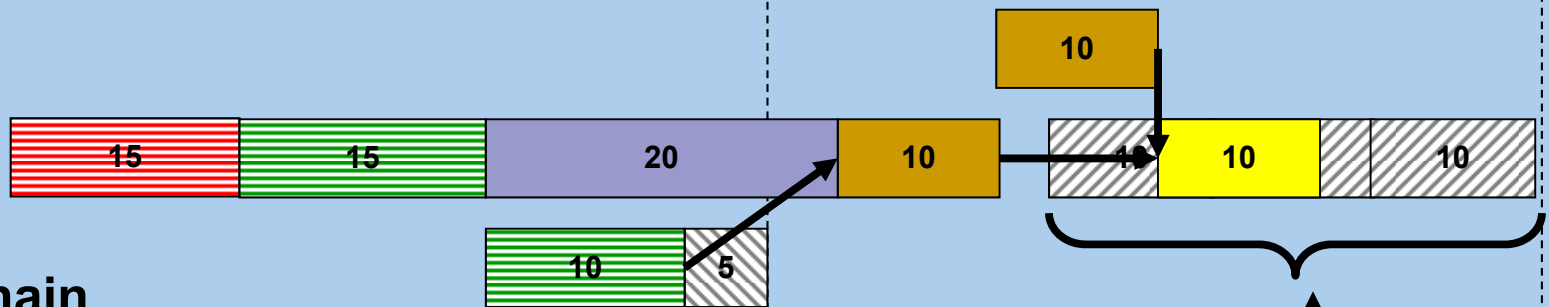

33% of Critical Chain Completed.
50% of Safety Consumed.
Are we in trouble?

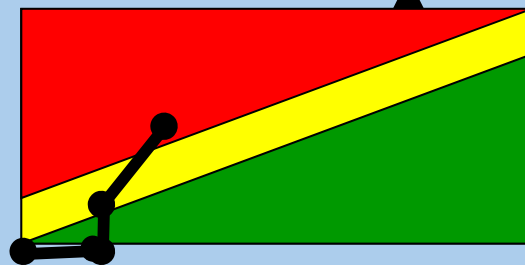

Expected Completion

Buffer Management Measures

Critical Chain Project Plan

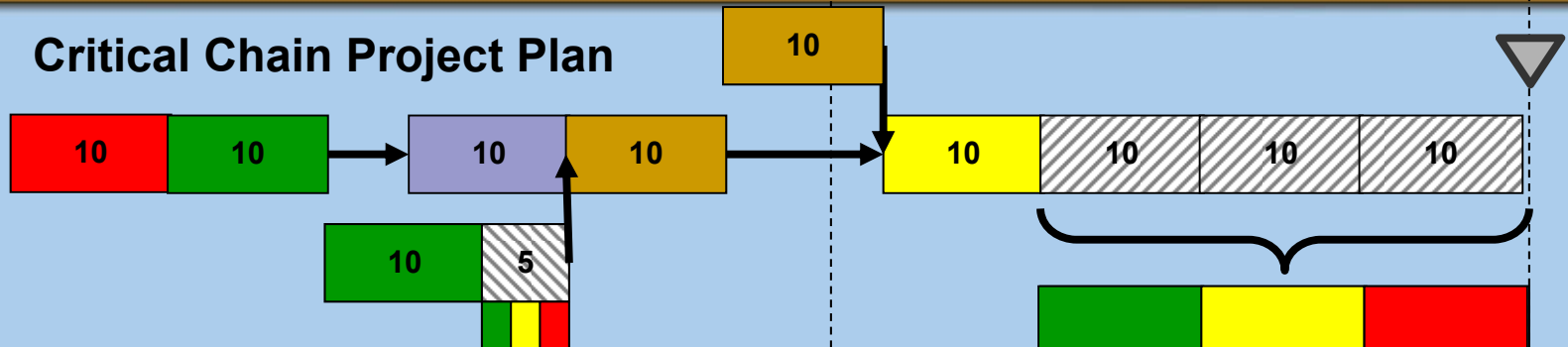

Safety Buffer

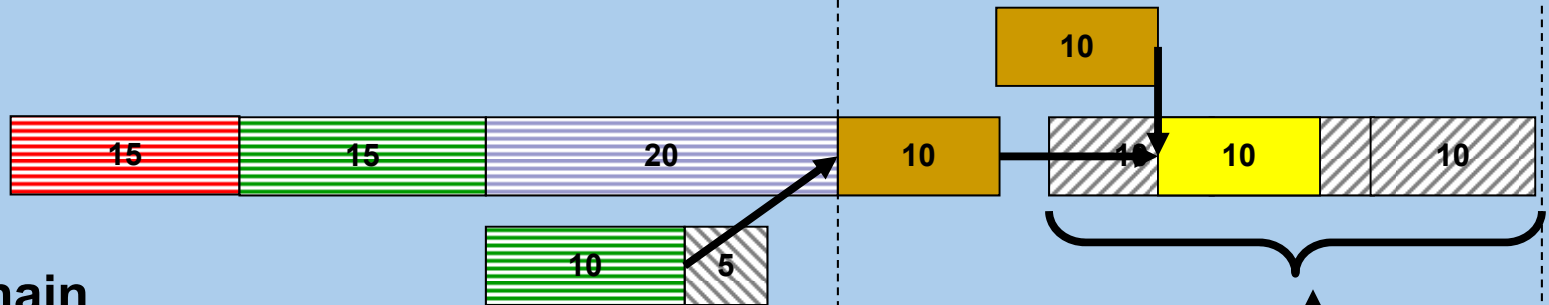

Example:

50% of Critical Chain Completed.
50% of Safety Consumed.
Are we in trouble?

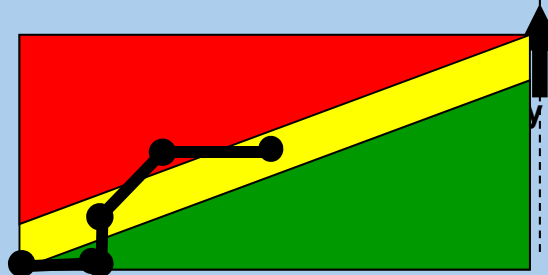

Expected Completion

Tracking Project Measures

TOCICO 2013 Conference

Green - Leave Things Alone
Yellow - Examine Processes
Red - Take Immediate Action (\$\$)

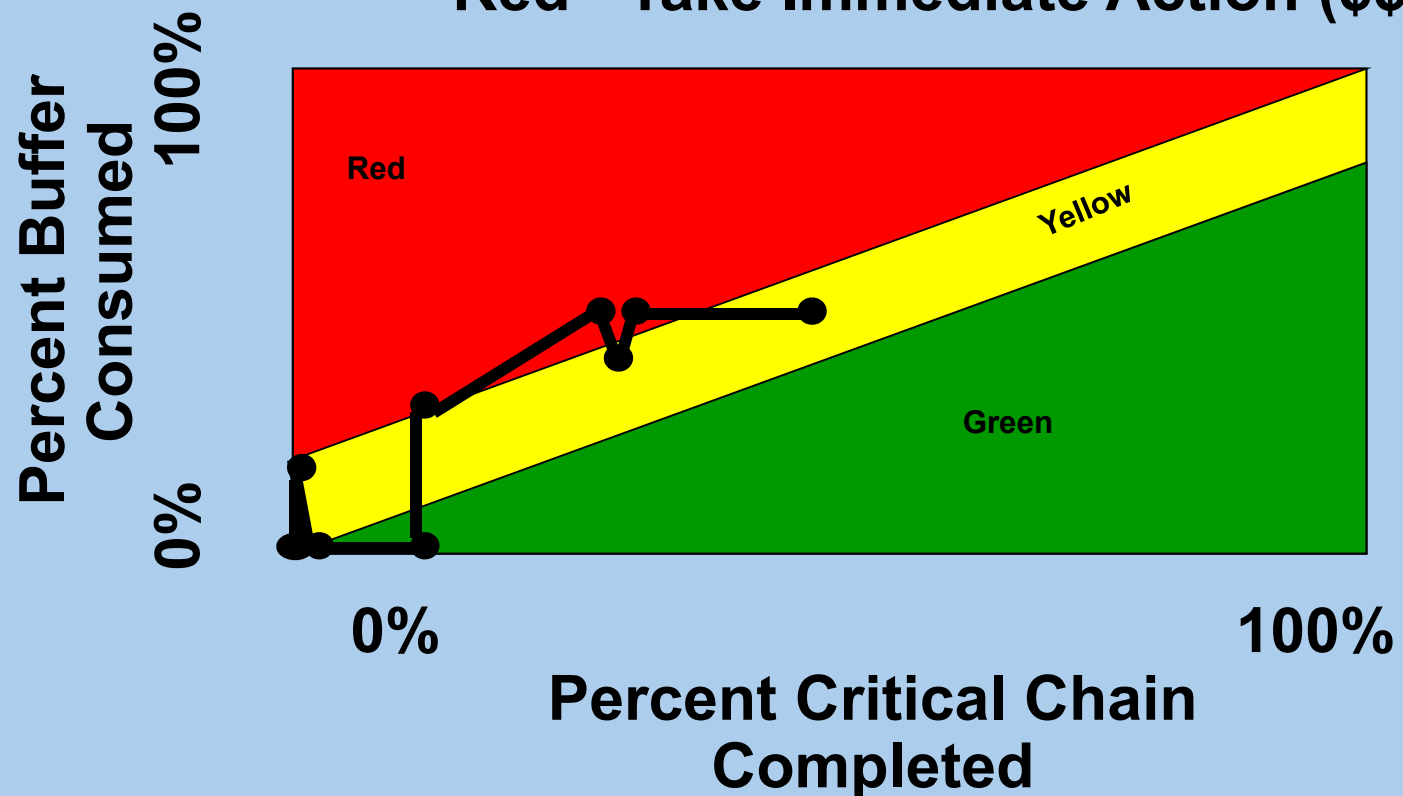

Dealing with Multi-Projects

Multi-Projects

- What if you have to do more than one project, with shared resources?

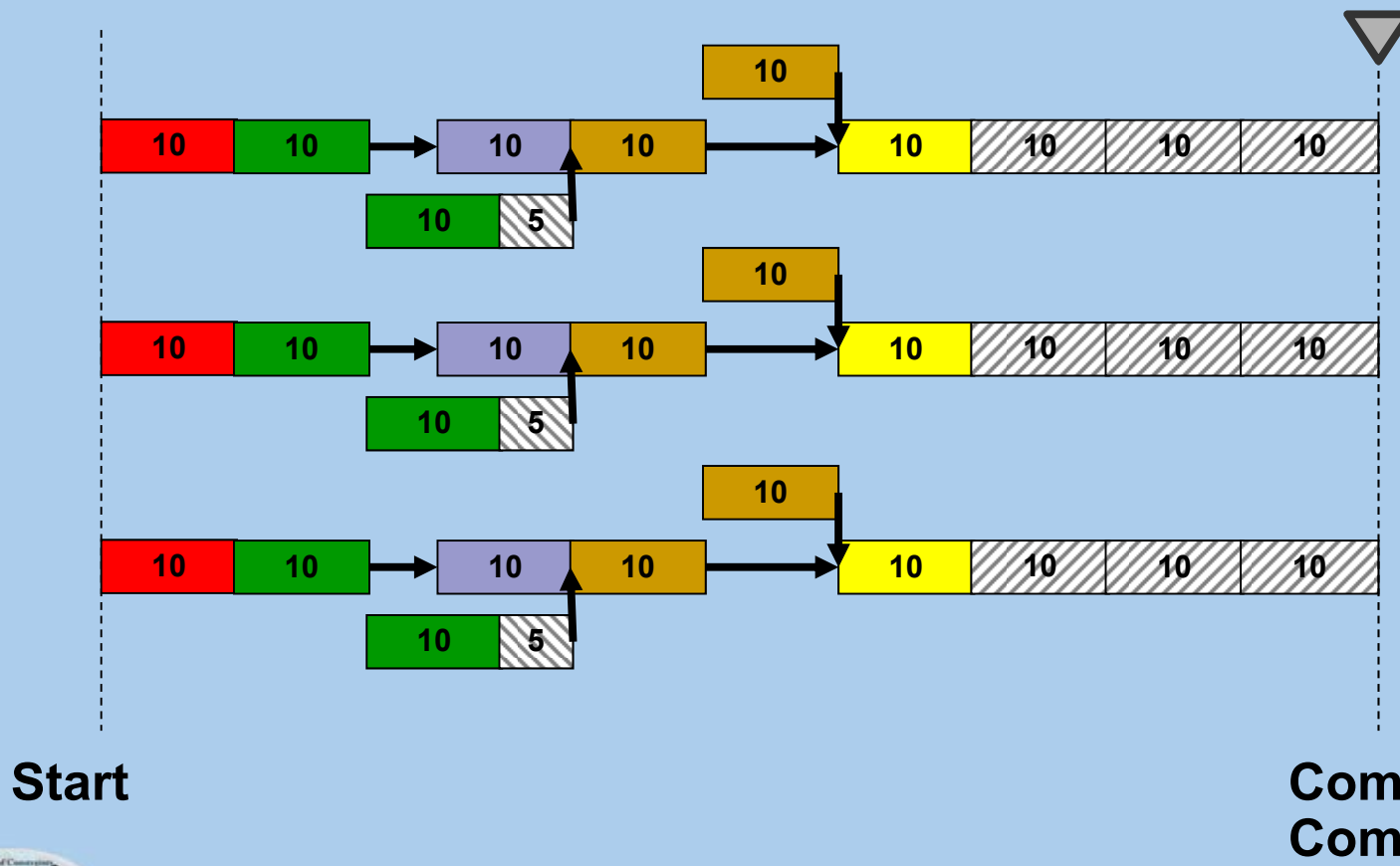

Based upon what we already know...



Bad Multi-Tasking would delay our best laid plans.

Sequencing

- We could sequence them based upon the capacity of the brown resource.

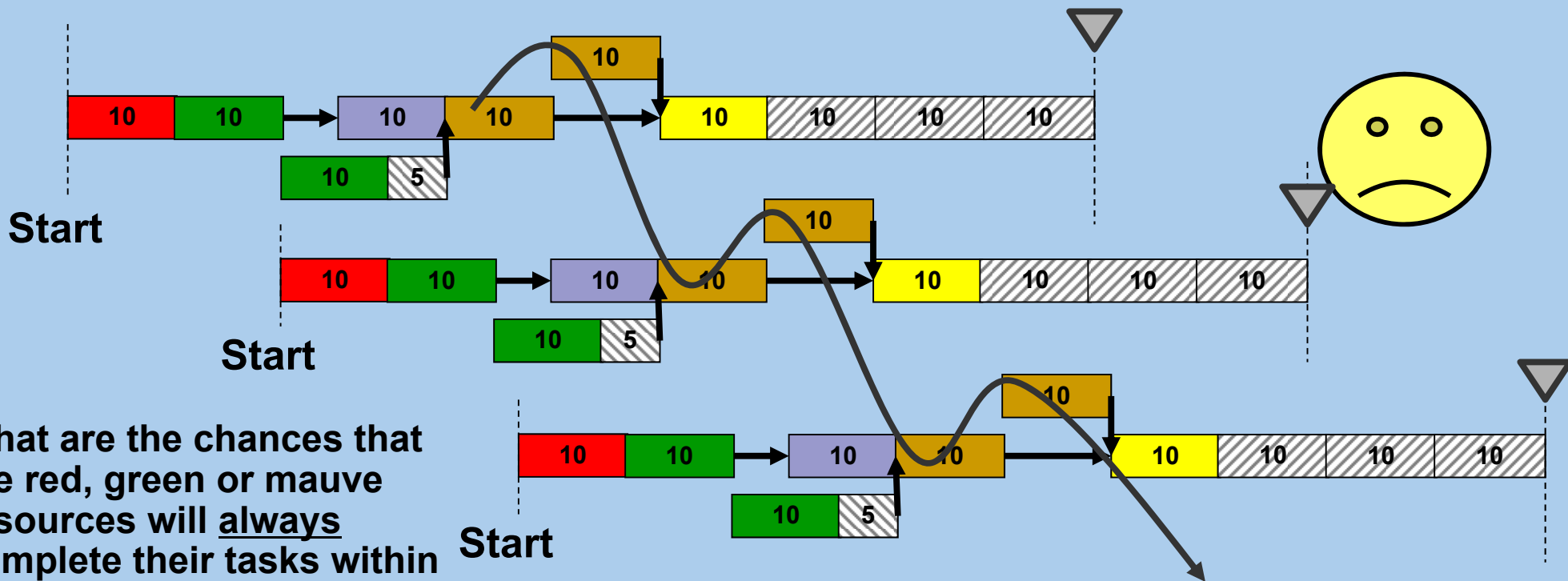

What are the chances that the red, green or mauve resources will always complete their tasks within the ten days of their aggressive schedule?

Start

Almost never will that happen!
One late task impacts all the projects that follow.

Committed Completions

Multi-Project Solution

TOCICO 2013 Conference

- **Insert Safety Between the Projects.**

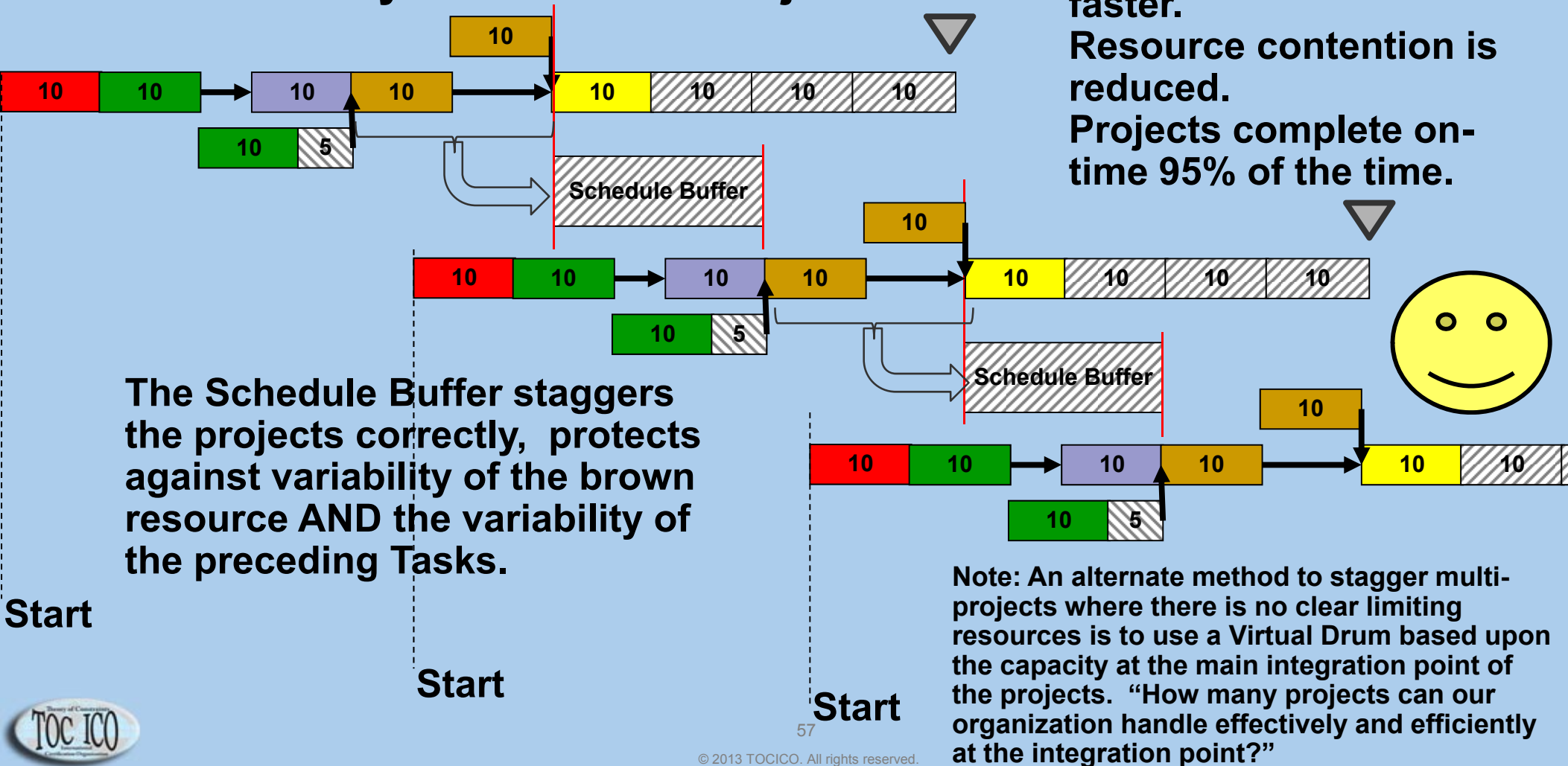

All projects complete faster.
Resource contention is reduced.
Projects complete on-time 95% of the time.

The Schedule Buffer staggers the projects correctly, protects against variability of the brown resource AND the variability of the preceding Tasks.

Note: An alternate method to stagger multi-projects where there is no clear limiting resources is to use a Virtual Drum based upon the capacity at the main integration point of the projects. "How many projects can our organization handle effectively and efficiently at the integration point?"

Start

Start

Start



Visual Tracking of Projects

TOCICO 2013 Conference

- **Single Project X**

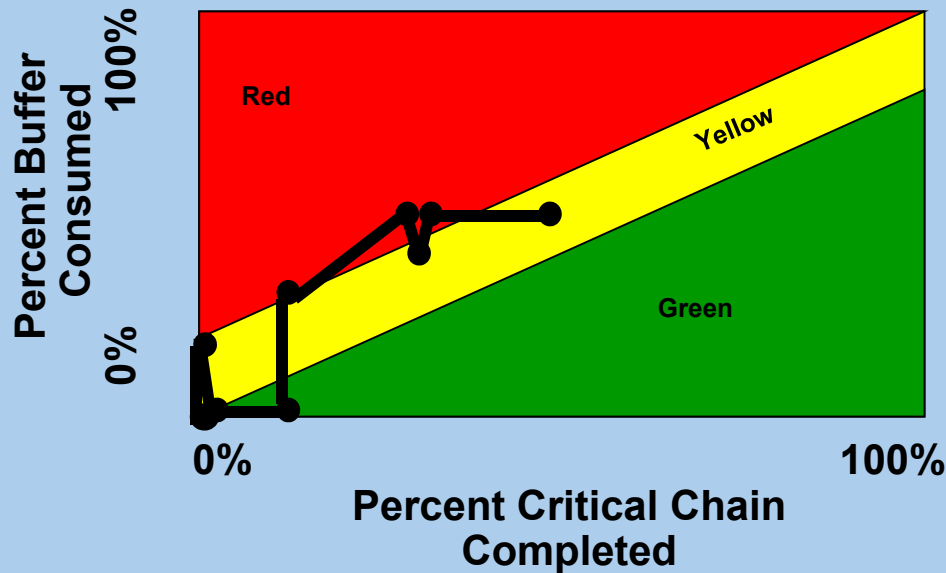

Multi-Project Report

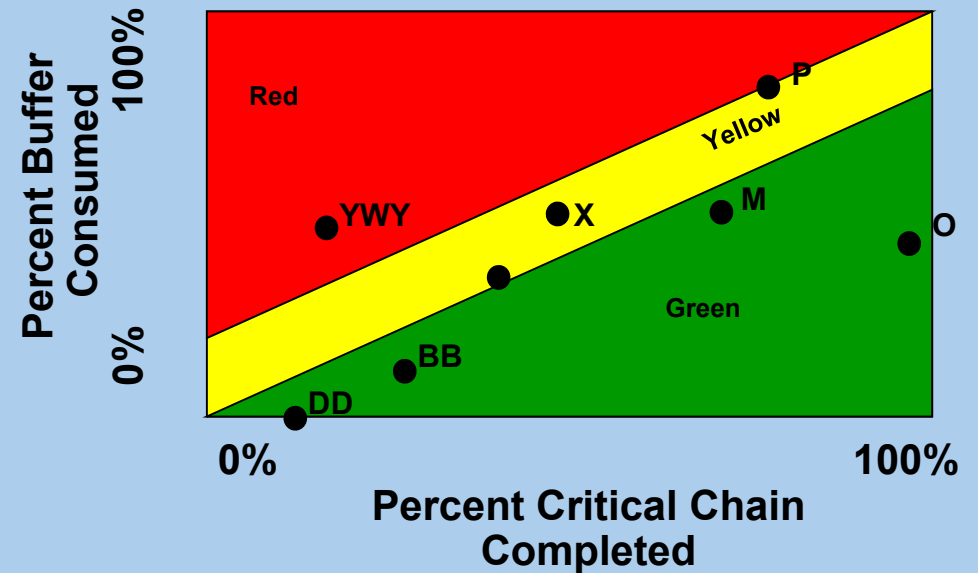

Project Management Benefits

TOCICO 2013 Conference

- **Very High Probability of Completion within Project Buffer (predictability).**
- **Shorter Project Flow Time (can do more projects in the same time).**
- **Quality Improves.**
 - **Better Focus (less distraction from bad multi-tasking).**
 - **No Rushed Start (All info available at start of work).**
 - **No Artificial Deadlines (completed work passed on when it is “Good Enough”).**
 - **Buffer Management provides resource help when needed.**

Bottom Line

TOCICO 2013 Conference

- **There is lots to gain.**
- **Particularly in Multi-Project Environments.**
- **Single Projects 25% reduction in flow time.**
- **Multi-Projects 50% reduction in flow time.**

- **Many successful implementations.**



A Quiz

- **1. You have two tasks from the same project assigned to you. You can work either task right now. One task is on the Critical Chain. The other is on a secondary Feeding Path. You should:**
 - **A. Ask the Project Manager what to do.**
 - **B. Do the task on the Feeding Path first to make sure it does not hold up the Critical Chain.**
 - **C. Do the task on the Critical Chain first.**
 - **D. Work a bit on one task and then a bit on the other until they are both finished.**

- **2. You are a special resource that is working on three task, each from a different project. You can work on any one of the tree tasks right now. Each task is on the Critical Chain of their project. You have one task from Project W, which is in the GREEN. You have one task from Project X, which is in the YELLOW. You have one task from Project Y which is in the RED. You should:**
 - **A. Ask the Project Manager what to do.**
 - **B. Do the task that is the quickest.**
 - **C. Do the task on Project Y first and then the task on Project X.**
 - **D. Do the task on Project Y first and then check the status of the other projects.**

- **3. You are the Project Manager of a project that is in the GREEN. There is another project managed by a different Project Manager that is in the RED. You should:**
 - **A. Be happy.**
 - **B. Do the task that is the quickest.**
 - **C. Volunteer to give resources from your project to the project in the RED.**
 - **D. Quickly finish your project.**

- **4. You are working on a Critical Chain task for a project that is in the YELLOW. But, you have been delayed for a long time awaiting a needed response from a different department in the company. You should:**
 - **A. Find something else to do (be productive).**
 - **B. Document who is causing the delay.**
 - **C. Ask for help from the Project Manager and others.**
 - **D. Carry-on the best you can.**

- **5. You are working on a Critical Chain task for a project that is in the YELLOW. A good friend calls you and asks you to assist him working on a Critical Chain task on a different project. You should ask you friend:**
 - **A. “What is the status of your project?”**
 - **B. “What favor will you do for me in return?”**
 - **C. “Who is your Project Manager?”**
 - **D. “How does your project affect me?”**

- **6. You have two tasks from two different projects. Both tasks are on the Critical Chain of their project. Both projects are in the RED. You should:**
 - **A. Work a little bit on each task until they are both done.**
 - **B. Find out which project is the most RED.**
 - **C. Find a different project to work on.**
 - **D. Focus on the task that can be completed the quickest.**

Additional Resources

TOCICO 2013 Conference

- ***Critical Chain***, Eliyahu M. Goldratt, The North River Press 1997.
- ***Project Management in the Fast Lane***, Robert C. Newbold, The St. Lucie Press, 1998.
- ***Critical Chain Project Management***, Lawrence P. Leach, Artech House, 2000.
- ***TOC Insights-Project Management and Engineering***, self-learning software, Eliyahu M. Goldratt and Rami Goldratt, www.toc-goldratt.com.
- **TOC CCPM: Project Implementation in less time (Japanese)**, Satouru Mirakami, Chukei Publishing, 2002.
- ***The Definitive Guide to Project Management: The Fast Track to Getting the Job Done on-time and on Budget***, Nokes, Major, Greenwood and Goodman, Prentice hall Financial Times, 2003
- ***Advanced Product Portfolio Management and the PMO***, Kendell and Rolins, J. Ross Publishing, 2003
- ***Lean Project Management***, Lawrence P. Leach, Advanced Project, Inc. 2005
- ***Goldratt und die Theory of Constraints (German)***, Techt, Uwe, Lulu Verlan, 2006.
- ***Projects in Less Time***, Marek Woepfel, Pinnacle Strategies Publishing, 2006
- ***Critical Chain – Beschleunigen sie ihr projekt management (German)*** Uwe Techt Uwe and Holger Lorz, Haufe Verlag, 2007
- ***The Billion Dollar Solution***, Robert C. Newbold, ProChain Press, 2008.
- ***The Theory of Constraints Handbook***, James F. Cox III and John G. Schleier, Jr., Chapters 2-5 by Ed Walker, Charlene Spoeede Budd, Janice Cervený, Realization Technologies and Rob Newbold, McGraw Hill, 2010.
- ***CCPM: Project Management the TOC Way***, Goldratt Schools, Productivity and Quality Publishing Private Limited, 2010.
- ***Be Fast or Be Gone***, Andreas Scherer, ProChain Press, 2011.
- ***Advanced Multi-Project Management***, Gerald I. Kendall and Kathleen M. Austin, J. Ross Publishing, 2013.
- ***The Phoenix Project***, Gene Kim, Kevin Behr and George Spafford, IT Revolution Press, 2013.